

ITV1000/2000/3000, Electro-Pneumatic Regulator ITV2050-31F3N3

Veri Sayfası

General series information

- Pressure range: 0.005 to 0.9 MPa
- Maximum flow rate: 4000 l/min (ANR)
- Port sizes: 1/8, 1/4, 3/8, 1/2
- Applicable fieldbus protocols: IO-Link, CC-Link, DeviceNet™, PROFIBUS, RS-232C.

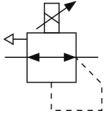

Electro-pneumatic regulator

Standard specifications

Input Signal	3 (Voltage Style 0~10VDC)
Options	None
Accessory	None
Pressure Range	5 (0.005~0.9MPa)
Pressure Display Unit	3 (Bar)
Port Size	3 (3/8 [2000,3000])
Model	20 (1500 L/min)
Power Voltage	0 (24VDC)
Monitor Output	1 (Analogue Output 1~5VDC)
Thread	F (G[PF])
Cable Connector	N (w/oCable Connector)
Maksimum basınç ortamı sıcaklığı	50 °C
Minimum basınç ortamı sıcaklığı	0 °C
Maksimum çalışma basıncı	1.0 MPa
Maksimum ortam sıcaklığı	50 °C
Minimum ambient temperature	0 °C
Onaylar	CE
Konektörlü koruma sınıfı	IP65
Current consumption	0.12 A

Enclosure	IP65
Sensitivity	0.2% (F.S.)
Repeatability	±0.5% (F.S.)
Set pressure range	0.005 - 0.9 MPa
Linearity	±1% (F.S.)
Power supply voltage	24 VDC ±10%
Min. supply pressure	Set pressure +0.1 MPa
Accuracy	±2%F.S. ±1 digit
Temperature characteristics	±0.12% (F.S.)/C
Minimum display unit	0.01
Hysteresis	0.5% (F.S.)
Input signal Voltage type	0 - 10 VDC
Input impedance current type	250 Ω
Input impedance Voltage type	6.5 kΩ
Output signal Analogue	1 to 5 VDC (Output impedance: Approximately 1 kΩ) Output accuracy within ±6% (Full span)
Ağırlık	0.350 Kg

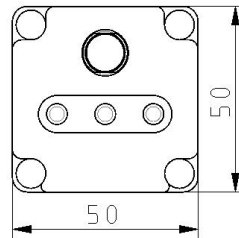
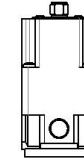
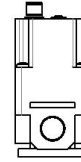
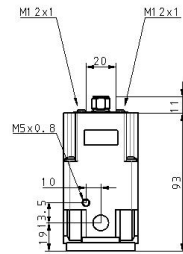
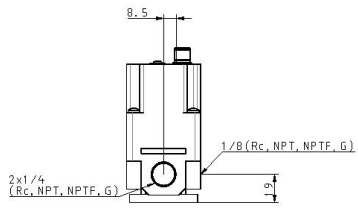
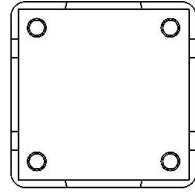

Yapı

ITV2000

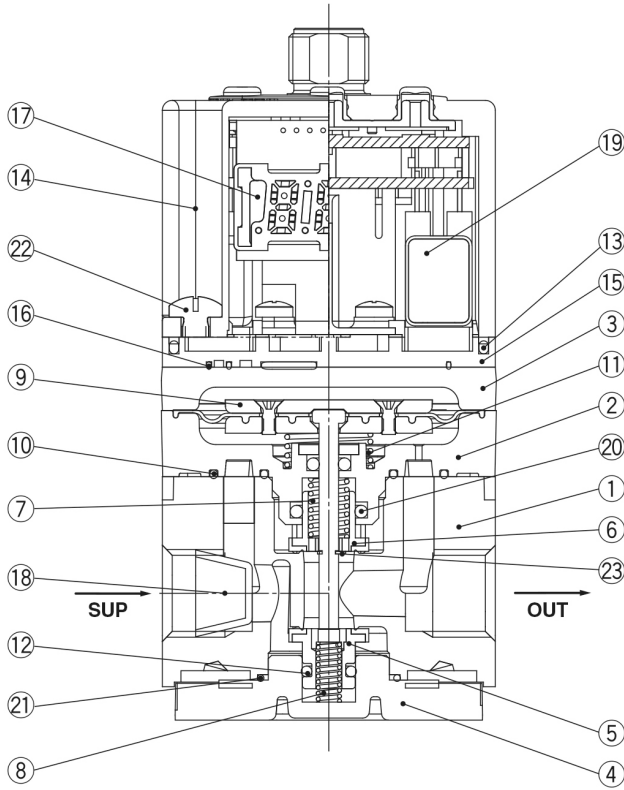

Main Component Parts

No.	Description	Material
◆ 1	Body	Aluminum alloy
◆ 2	Intermediate body	Aluminum alloy
3	Cover	Aluminum alloy
◆ 4	Valve guide	Aluminum alloy
◆ 5	Valve (Supply valve)	HNBR/Brass
◆ 6	Valve (Exhaust valve)	HNBR/Brass
◆ 7	Valve spring	Stainless steel
◆ 8	Valve spring	Stainless steel
◆ 9	Diaphragm assembly	Stainless steel
		Aluminum alloy
		HNBR
		Steel
◆ 10	Seal	NBR
◆ 11	Bias spring	Stainless steel
◆ 12	O-ring	NBR
13	Seal	NBR
14	Bowl assembly	Resin
		Silicone rubber
15	Sub-plate	Resin
16	Seal	NBR
17	Control circuit assembly	—
◆ 18	Filter	Stainless steel
19	Solenoid valve	—
◆ 20	O-ring	NBR
21	O-ring	NBR
22	Round head Phillips screw	Steel
◆ 23	Retaining ring	Stainless steel

* Parts in contact with fluid are indicated with a mark ◆.

Ek Bilgi

Katalog	ITV-G_EU.pdf
Declaration of conformity	newDoC_ITVx000-G_EN.pdf newDoC_ITVx000-H_EN.pdf newDoC_ITVx000_IO-Link-EN.pdf DoC_ITVx_TF00023-B.pdf
Installation manuals	IM_ITVx000_EN-A.pdf IM_ITVx000-IO-Link_EN.pdf IM_ITV3000_EN-A.pdf
Operation manuals	OM_ITVx000-60_EN-D.pdf OM_ITVx000-CC-Link_EN-D.pdf OM_ITVx000-PROFIBUS-DP_EN-A.pdf OM_ITVx000-IO-Link_EN-A.pdf OM_ITVx000-52_53_EN-E.pdf OM_ITVx000-DeviceNet_EN-E.pdf OM_ITVx000-RS-232C_EN-A.pdf OM_ITVx000_DOC1070538EN-1.pdf