

In linea - AS*2F-A AS2052F-08A

Scheda tecnica

General series information

- Diam. est. tubo applicabile: da Ø 3.2 a Ø 12 mm e Ø 1/8" a Ø 1/2"
- Campo pressione d'esercizio: da 0.1 a 1 MPa.



*Valvola di non ritorno, valvola di controllo per
flusso unidirezionale, regolabile*

Specifiche standard

Adattatore per montaggio a pannello	Nessuno
Dimensione corpo	205 (1/4 Standard)
Diametro esterno tubo applicabile	08 (ø8)
Fluido di Pressione	Aria
Pressione massima di esercizio	1 MPa
Pressione minima di esercizio	0.1 MPa
Proof pressure	1.5 MPa
Massima temperatura ambiente	60 °C
Minima temperatura ambiente	-5 °C
Materiale tubo utilizzabile	nylon, nylon morbido, poliuretano, FEP, PFA
Weight	0.014 Kg

Dimensioni

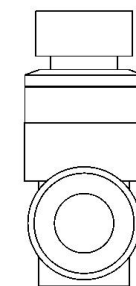
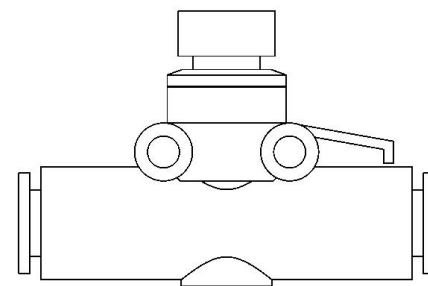
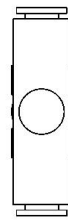
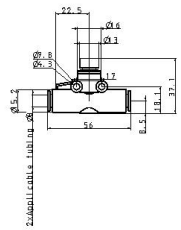

Costruzione

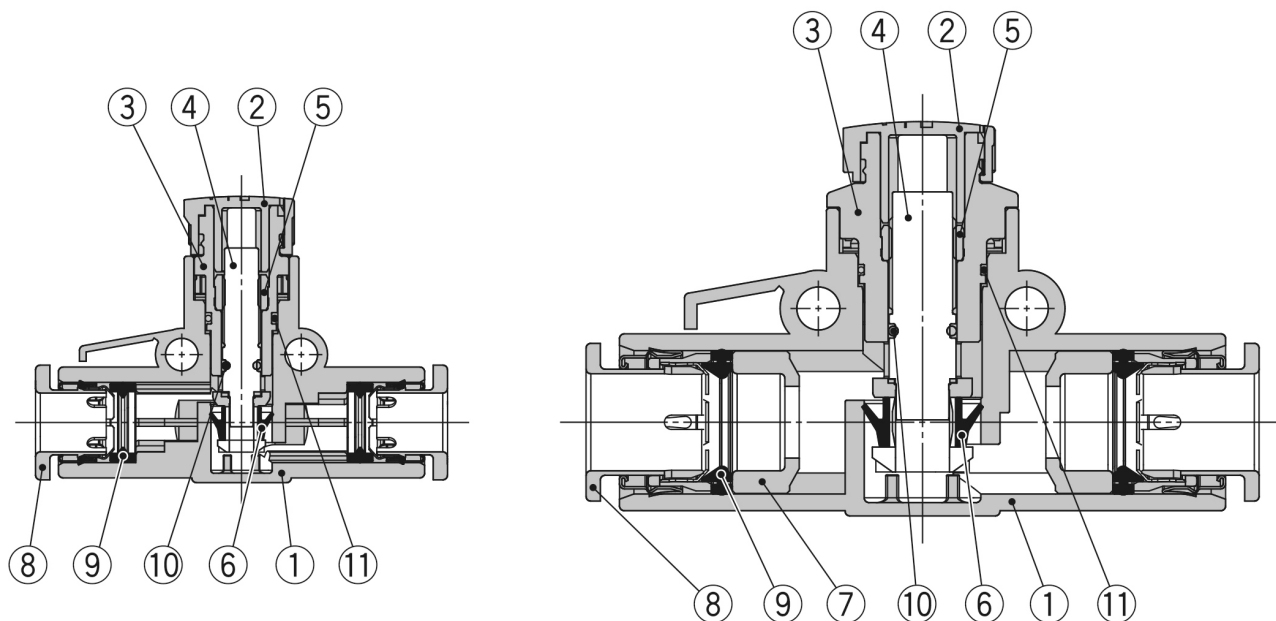

Componenti

N.	Descrizione	Materiale	Nota
1	Corpo A	PBT	
2	Manopola	POM	
3	Corpo B	PBT	
4	Spillo	PBT	
5	Guida spillo	Ottone	Nichelato per elettrolisi
6	Guarnizione a U	HNBR	
7	Distanziale	PBT*1	
8	Collare	—	
9	Guarnizione di tenuta	NBR	
10	O-ring	NBR	
11	O-ring	NBR	

*1: I tipi AS3002F-11A, AS4002F-11A, AS4002F-13A sono in ottone nichelato per elettrolisi.

Informazioni aggiuntive

Catalogue

[AS-C_in-line_IT.pdf](#)