

**En ligne - AS\*2F-A  
AS2002F-06A**

Fiche technique

## General series information

- Diam. ext. du tube utilisable: Ø 3.2 à Ø 12 mm et Ø 1/8" à Ø 1/2"
- Plage de pression d'utilisation: 0.1 à 1 MPa.



*Clapet antiretour, régulateur de débit  
unidirectionnel, réglable*

## Standard Specifications

Adaptateur pour montage sur panneau	Sans
Taille du corps	200 (1/8 Standard)
Diam. ext. de tube utilisable.	06 (ø6)
Pression du fluide	Air
Pression maximale d'utilisation	1 MPa
Pression minimale d'utilisation	0.1 MPa
Proof pressure	1.5 MPa
Température ambiante max.	60 °C
Température ambiante min.	-5 °C
Matériau de tube compatible	Nylon, polyamide souple, polyuréthane, FEP, PFA
Poids	0.009 Kg

# Dimensions

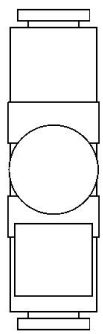
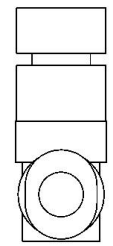
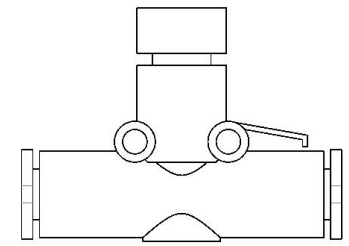
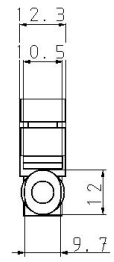
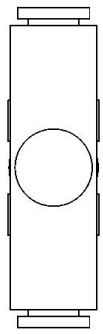
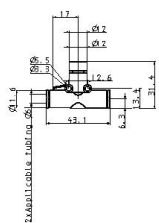

## Constructions

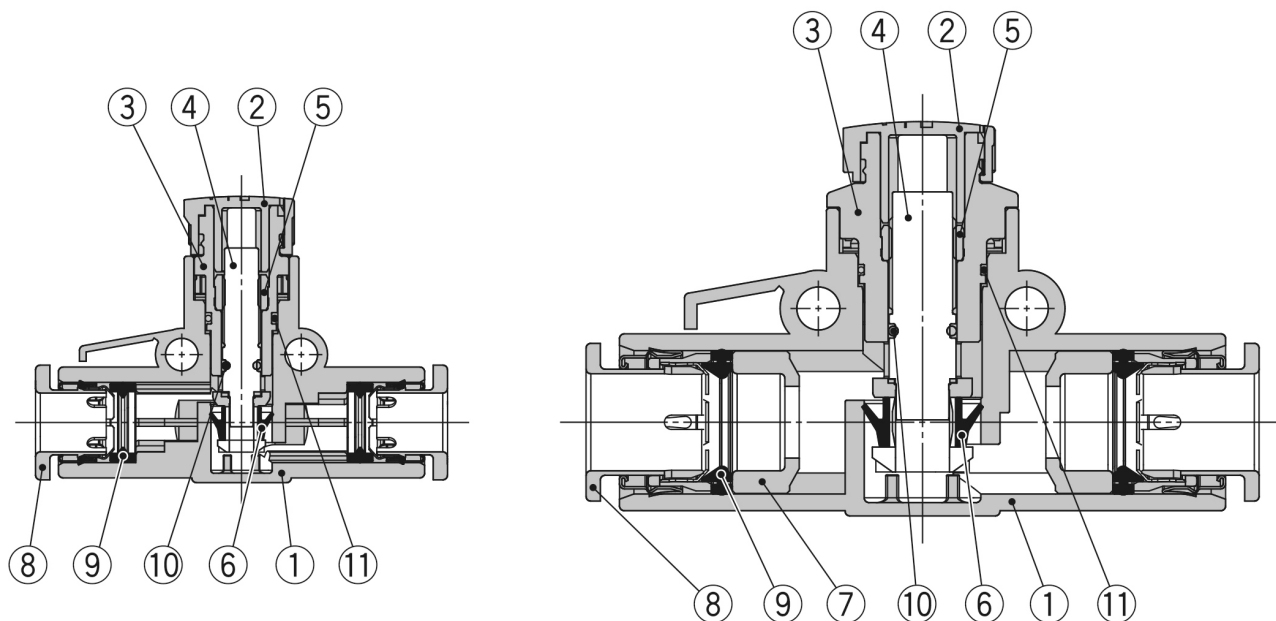

### Nomenclature

N°	Description	Matériau	Note
1	<b>Corps A</b>	PBT	
2	<b>Bouton de réglage</b>	POM	
3	<b>Corps B</b>	PBT	
4	<b>Vis</b>	PBT	
5	<b>Guide</b>	Laiton	Nickelage anaélectrolytique
6	<b>Joint en U</b>	HNBR	
7	<b>Entretoise</b>	PBT*1	
8	<b>Cassette</b>	—	
9	<b>Joint</b>	NBR	
10	<b>Joint torique</b>	NBR	
11	<b>Joint torique</b>	NBR	

\*1 :Les AS3002F-11A, AS4002F-11A, AS4002F-13A sont en laiton nickelé (nickelage anaélectrolytique).

## Information supplémentaire

Catalogue

[AS-C\\_in-line\\_FR.pdf](#)