



SMC SOLUTIONS FOR SEAFOOD INDUSTRY

Your seafood partner, from ocean to table

Expertise
Passion
Automation



Expertise across seafood processing

Discover the fish industry, a dynamic and essential sector that brings high-quality seafood from oceans and farms to tables around the world. Combining centuries of tradition with modern innovation, the industry embraces both wild catching and aquaculture to ensure a stable and sustainable supply of fish.

We bring extensive expertise in seafood processing applications, supporting manufacturers with specialised products used across a wide range of fish processing machinery. Our solutions are designed to perform reliably in demanding, high-throughput environments where precision, hygiene and repeatability are essential.

From early-stage operations to final processing steps, our products are integrated into equipment for key seafood processes including stunning and bleeding, gutting, desliming, grading, cutting, filleting, pin-boning, skinning, portioning and packaging. This broad process coverage allows manufacturers to rely on proven technologies throughout the entire production line.

By focusing on performance, durability and application know-how, we help manufacturers develop machines that deliver consistent quality, optimised yield and efficient operation—whether installed in land-based plants or adapted for onboard processing.

SMC – Your seafood partner, from ocean to table

Machines for seafood processing

You face unique challenges, and we know them well

Imagine designing a machine that has to survive saltwater, constant washdowns, fluctuating temperatures and the impact of hundreds of kilos of fish moving through it every hour. In the seafood industry, equipment doesn't just work hard, it works in one of the harshest environments in food production. And when hygiene, uptime and safety are non-negotiable, every component matters. This is where SMC can support you. For years, we have been working with seafood processors and machine builders operating in highly corrosive, high-humidity environments. This experience has given us the know-how to help you overcome the sector's toughest constraints: durability, hygiene, compact machine design and compliance with strict food-safety regulations.



MARTIN SKOVSGAARD
JENSEN
Seafood processing specialist

What SMC brings to your seafood machinery:

- **Stainless steel and corrosion-resistant components** designed to withstand saltwater, aggressive detergents and continuous cleaning cycles
- **Hygienic, food-grade designs** that support compliance with the most demanding global standards
- **High-IP-rated actuators and valves** that deliver long service life in wet and washdown zones
- **Energy-efficient products** that reduce air consumption and support sustainable machine design
- **Compact and lightweight solutions**, ideal for space-restricted equipment where every centimetre counts.

Don't let harsh conditions dictate your machine performance.

Let SMC help you design reliable, hygienic and compliant seafood processing equipment, built to run, day after day. Reach out to your local SMC representative and let's create a solution tailored to your environment.

Seafood processing solutions for onboard applications

Seafood processing onboard large fishing vessels follows the same core principles as land-based operations. Key processes such as stunning and bleeding, gutting, grading, filleting, trimming, portioning and packaging are increasingly carried out at sea to preserve freshness and ensure consistent product quality from the moment of catch. We supply specialised products and technologies to manufacturers who design and build processing machinery for both

onshore plants and large vessels. Our solutions are integrated into equipment used across the full range of seafood processing steps, enabling reliable and repeatable performance in demanding marine environments.

Designed to meet the requirements of onboard operation, our products support compact machine designs, hygienic

processing and robust performance under continuous motion and corrosive conditions. By using the same core technologies on land and at sea, manufacturers can standardise machine platforms while adapting them efficiently for vessel installations.

With a strong presence across multiple seafood processes, our products help manufacturers deliver consistent quality, efficiency and reliability — whether processing takes place in a factory or onboard a vessel.

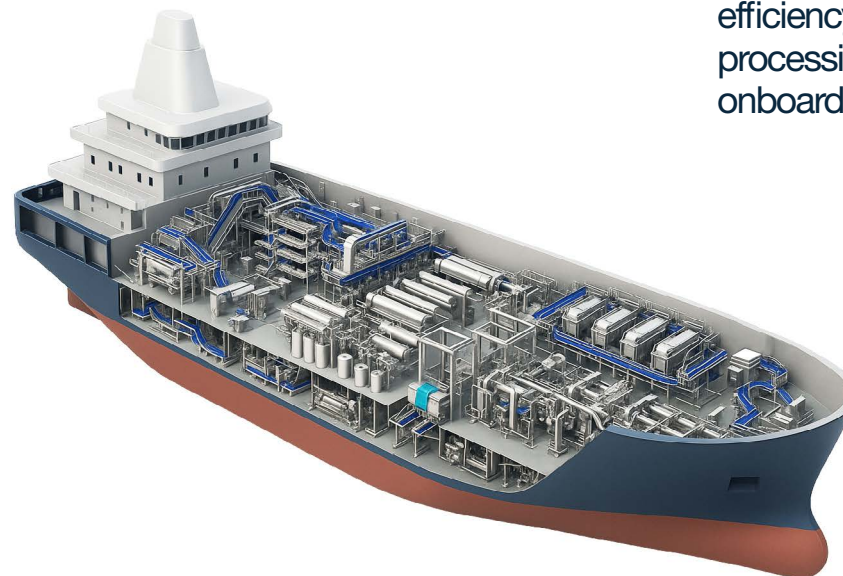

Supporting every step of your seafood journey

From the careful handling of live fish to the final packaging stage, the seafood industry relies on precise, hygienic and reliable operations. Each phase demands full control, robust equipment and consistent performance to ensure both product quality and process efficiency. By deeply understanding every step of your fish processing workflow, we help you identify the right solutions to enhance safety, reduce downtime and maintain the highest standards throughout the entire line.

Aqua farming

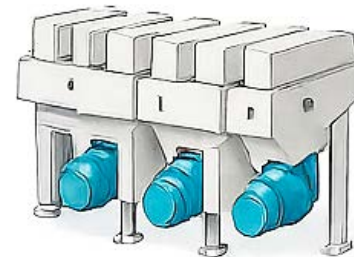

Delicer



Vaccination

Supporting every step



Electric stun and bleed



Gutting



Desliming

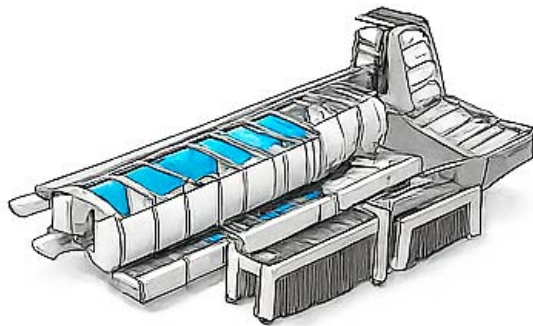

Grader



Head, fins and tail cutting

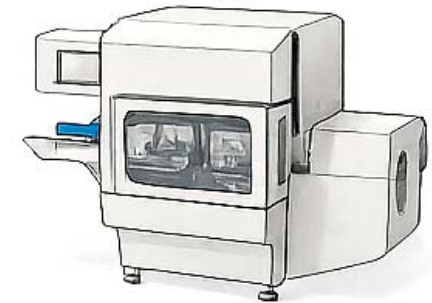

Fillet machine

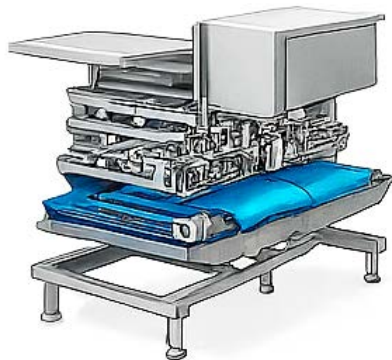

Pin-boner

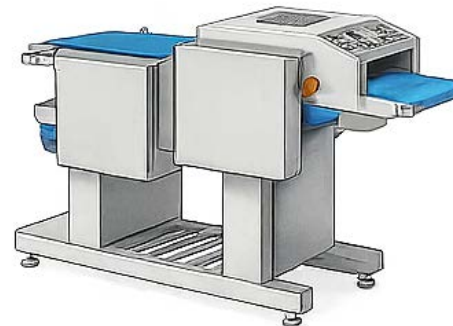

Skinner



Portioning

Delicer

Delicing is an essential process in aquaculture aimed at removing fish lice to protect fish health and ensure stable production conditions. Fish lice are often species-specific, with certain parasites affecting only particular fish families, such as salmonids. Effective delicing is therefore a critical operational requirement in modern fish farming.

Delicing is carried out using non-chemical methods, primarily thermal and mechanical treatment. In thermal delicing, fish are exposed to controlled heated water to neutralise lice, while mechanical systems use carefully regulated water flows to detach and remove parasites from the fish surface. Both methods are designed to minimise stress while delivering reliable and repeatable results.

Delicing systems are commonly installed on specialised vessels, including delicing vessels and well boats, where robust, hygienic and high-performance machinery is required. Integrated into dedicated delicing equipment, these systems support efficient onboard operation and contribute to healthier stock, improved welfare and more predictable aquaculture performance.

Suitable products +



Vaccination

Vaccination is a critical operation in aquaculture processing, protecting fish health and improving survival rates throughout the production cycle. Automated vaccination systems accurately deliver the correct dose to each fish, ensuring consistent application while minimising stress and handling time. Precise positioning and gentle handling are key to maintaining animal welfare during this process.

Through automation and high repeatability, vaccination units improve operational efficiency and reduce labour dependency. This results in healthier stock, improved growth performance and more predictable production outcomes, supporting long-term sustainability and profitability.

Suitable products +

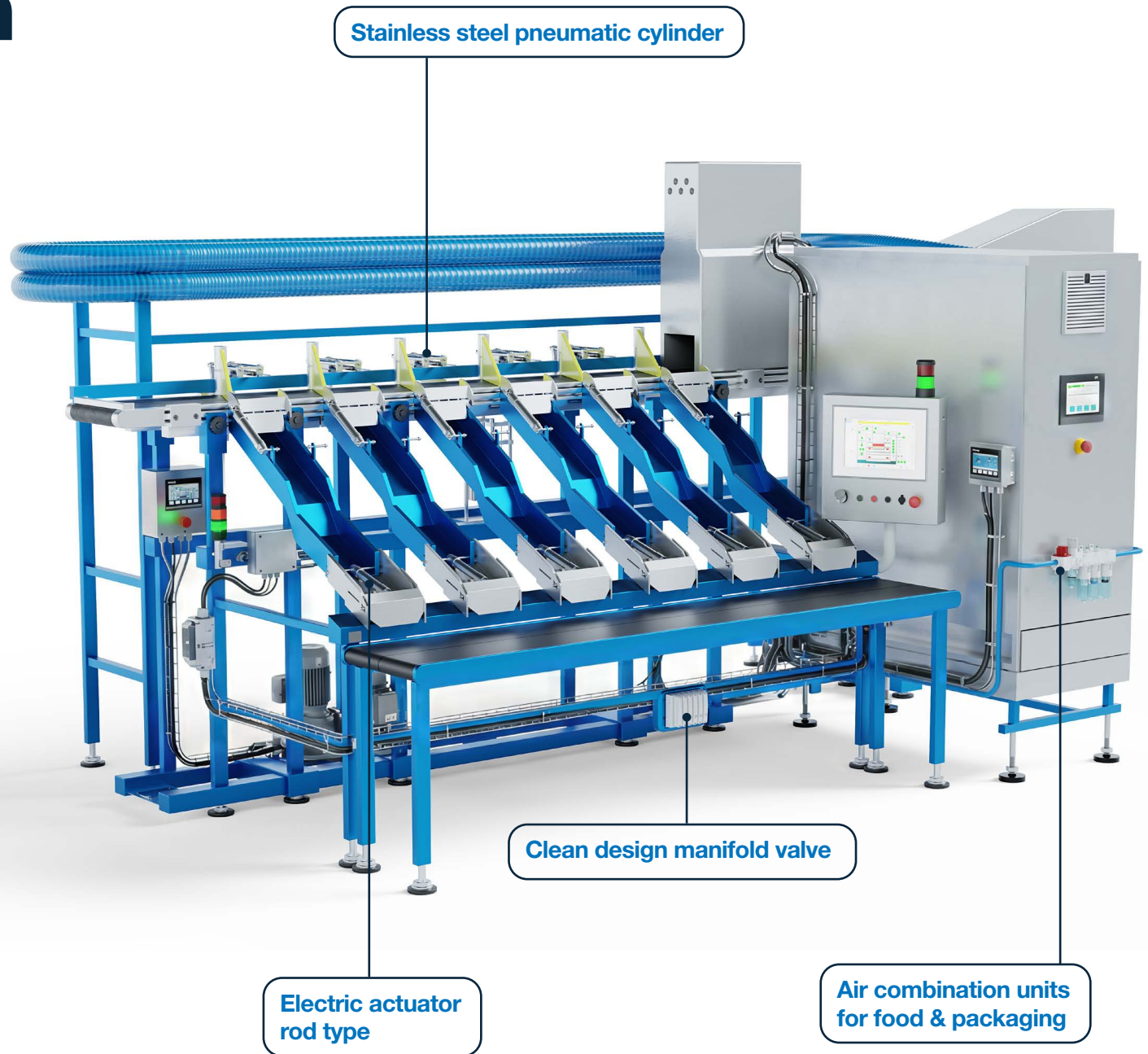

Electric stun and bleed, with cutting robot

Stunning and bleeding is a vital step that ensures animal welfare while directly influencing final product quality. Fish are humanely stunned using controlled electrical or percussive methods, followed immediately by an efficient bleeding process that removes blood from the muscle tissue. This rapid sequence minimises stress and preserves flesh quality.

By combining humane handling with effective blood removal, modern stun and bleed systems deliver whiter fillets, longer shelf life and improved sensory properties. The process also creates a stable foundation for downstream operations such as gutting and filleting, ensuring consistent results at high throughput.

Suitable products +

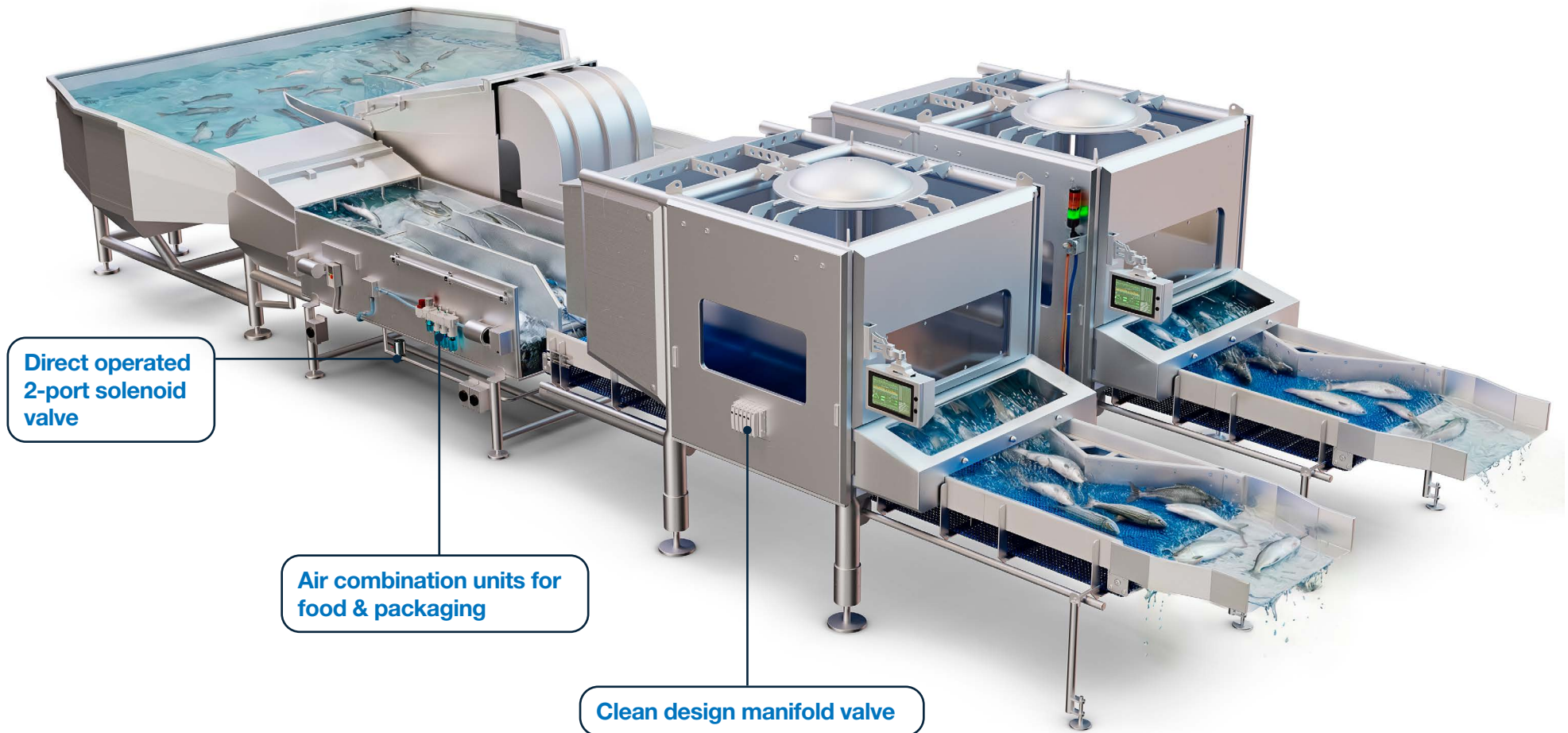

Direct operated
2-port solenoid
valve

Air combination units for
food & packaging

Clean design manifold valve

Gutting

Gutting is a crucial stage in fish processing, ensuring product quality, hygiene and consistency from the very start of the line. During this step, a precision-guided knife opens the fish, while an integrated brushing system removes the internal organs efficiently. Water jets help loosen remaining material, and a vacuum system extracts waste reliably to keep the cavity clean and ready for subsequent operations.

By combining controlled cutting, hygienic removal and continuous waste extraction, modern gutting units deliver a stable, repeatable and food-safe process. This not only supports high throughput and reduced manual handling, but also ensures cleaner downstream stages such as filleting and trimming, enhancing overall product yield and quality.

Suitable products +

Stainless steel pneumatic cylinder

Electro-pneumatic regulator/electronic vacuum regulator

Plug-in bottom ported manifold with stainless steel plate

Direct operated 2-port solenoid valve

Deslimer

Desliming removes mucus, blood residues and surface contaminants from the fish after gutting or bleeding. Using rotating brushes, controlled water flows or spray systems, the fish surface is cleaned thoroughly without damaging the skin or flesh. This step improves visual appearance and prepares the product for accurate grading and cutting.

By ensuring a clean and uniform surface, deslimer systems enhance hygiene and reduce cross-contamination risks. This leads to improved process stability in subsequent operations and contributes to higher overall product quality and shelf life.

Suitable products [+](#)



Grader

Grading sorts fish or fillets according to size, weight or quality parameters using advanced sensor and weighing technologies. Each product is measured individually and directed to the correct output channel with high accuracy, ensuring consistent batch composition. The process operates at high speed while maintaining gentle product handling.

Accurate grading optimises production planning, yield control and portion consistency. By delivering uniform input to downstream machines, graders improve cutting accuracy, reduce waste and support efficient order fulfilment.

Suitable products +

Clean design manifold valve

Stainless steel throttle valve with one-touch fittings

Stainless steel pneumatic cylinder

Air combination units for food & packaging

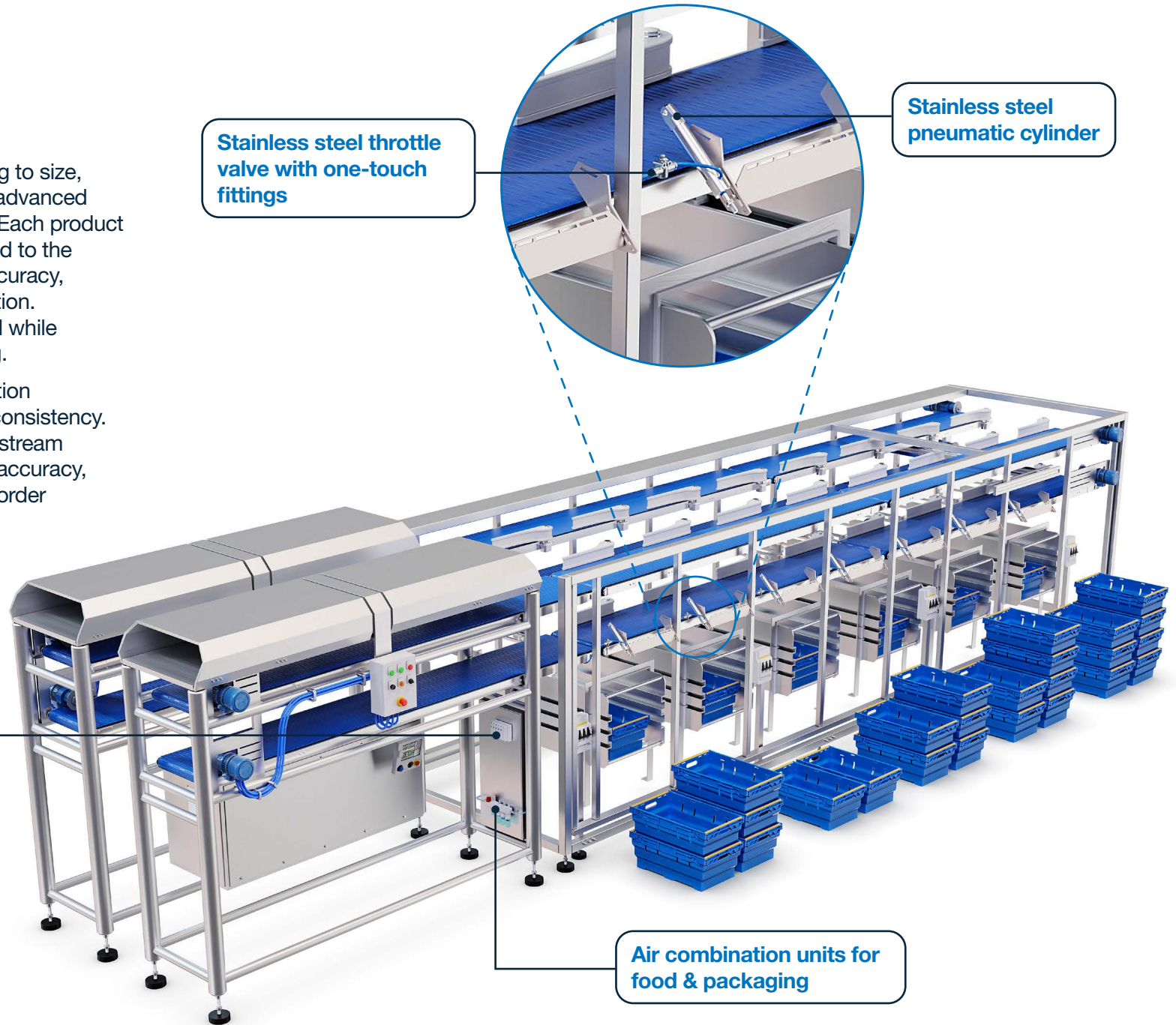

Head, fins and tail cutting

Head, fin and tail cutting is a precision process that prepares fish for filleting or portioning. Automated cutting units use adjustable blades and positioning systems to remove unwanted parts with consistent accuracy, regardless of fish size variation. Clean cuts are essential to maximise usable meat and minimise damage.

By standardising this operation, modern cutting machines reduce manual labour and improve yield control. Consistent trimming also ensures better alignment and performance in subsequent filleting and processing stages.

Suitable products +



Fillet machine

Filleting separates the edible flesh from the backbone with high precision and repeatability. Using guided knives and adaptive positioning systems, fillet machines follow the natural shape of each fish to maximise yield while maintaining fillet quality. The process is optimised for speed, hygiene and minimal manual intervention.

Automated filleting delivers consistent fillet dimensions, reduced bone residue and improved throughput. This not only enhances product quality but also provides stable input for further processing steps such as pin-boning, skinning and portioning.

Suitable products +

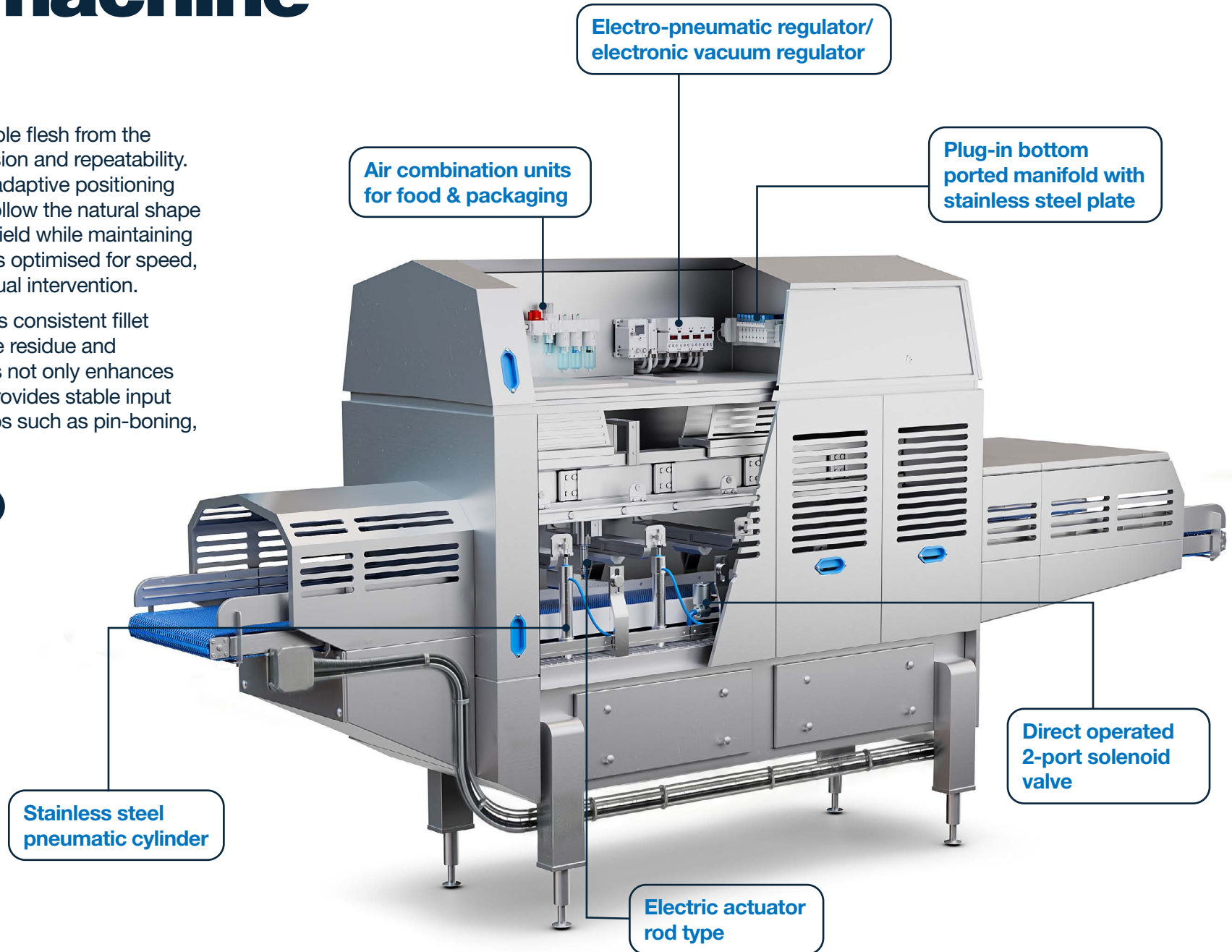

Pin-boner

Pin-boning removes fine intramuscular bones from fillets using precision pulling or detection systems. The process targets pin bones accurately without damaging the surrounding flesh, preserving the fillet's structure and appearance. Careful control is essential to maintain product integrity.

By ensuring bone-free fillets, pin-boners significantly improve consumer experience and product safety. Automation also increases throughput and consistency, reducing reliance on manual trimming and inspection.

Suitable products +



Skinner

Skinning separates the skin cleanly from the fillet using controlled pressure and blade systems. The process maintains fillet thickness and surface quality while adapting to variations in size and texture. Accurate skin removal is essential for premium presentation and further portioning.

Modern skimmers deliver high yield with minimal flesh loss, supporting consistent product quality. The result is a uniform fillet surface that meets market requirements and improves performance in downstream operations.

Suitable products +



Portioning

Portioning cuts fillets into precise weights or dimensions according to customer specifications. Advanced scanning and cutting technologies calculate optimal cut patterns to maximise yield while meeting strict portion tolerances. Each portion is cut cleanly and consistently.

By combining accuracy and flexibility, portioning systems enable efficient order customisation and reduced giveaway. This supports higher profitability while delivering uniform, high-quality portions ready for packaging.

Suitable products +

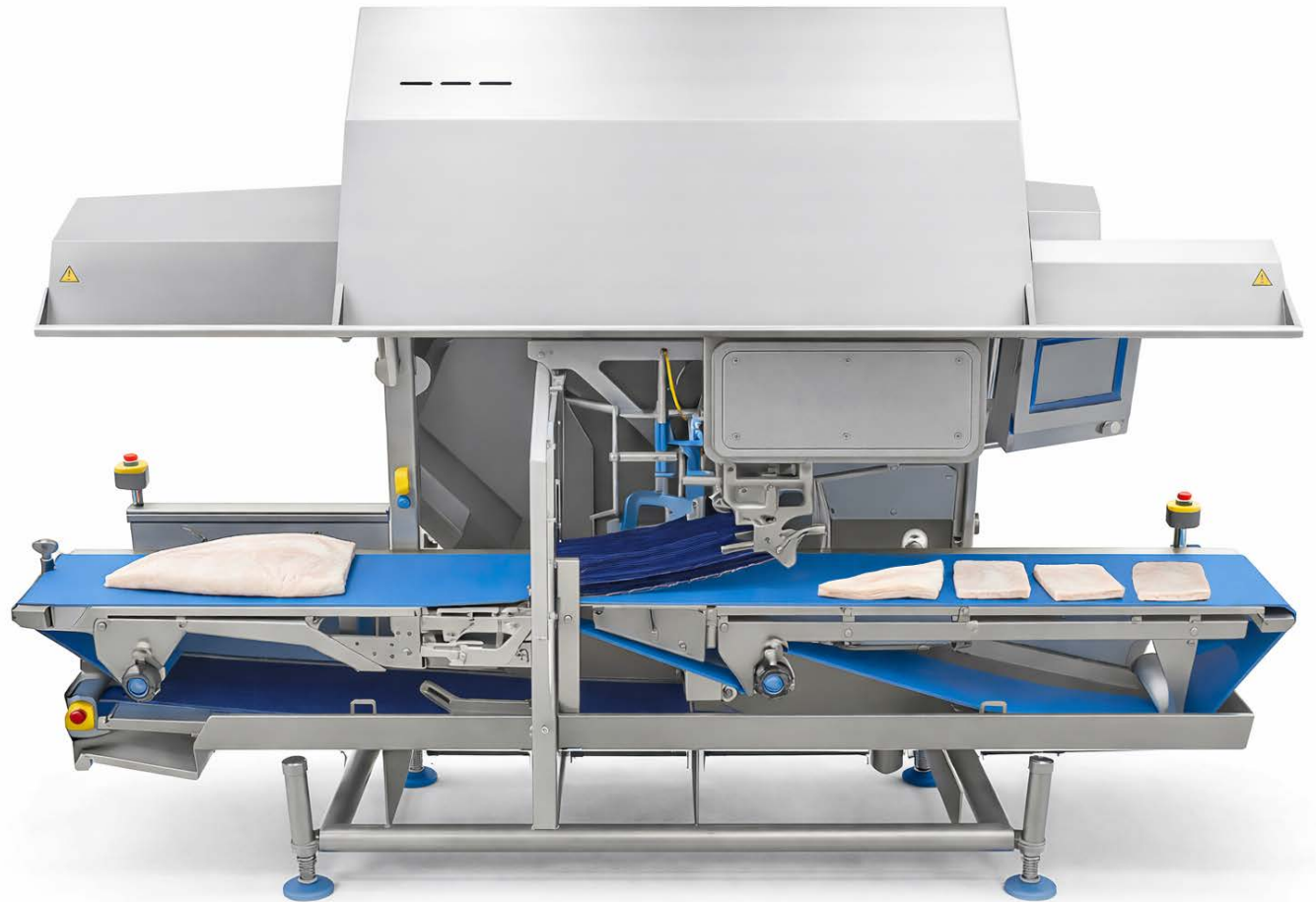

Products by solution

Pneumatic actuators



Stainless steel cylinder non-adjustable air cushion type
HF2A-CG5 Series +



Pin cylinder: single acting, spring return
CJP-Z Series +



Compact cylinder, guide rod type
C(D)QM Series +



Magnetically coupled rodless cylinder
CY3-Z Series +



ISO standard 15552 air cylinder
HF1A-CP96 Series



Rotary table rack & pinion type
MSQB1-7 Series +

	DELICER	VACCINATION	STUN AND BLEED	GUTTING	DESLIMER	GRADER	HEAD, FIN AND TAIL CUTTER	FILLET MACHINE	PIN-BOONER	SKINNER	PORTIONING
Stainless steel cylinder non-adjustable air cushion type	🐟	🐟	🐟	🐟		🐟		🐟	🐟	🐟	
Pin cylinder: single acting, spring return		🐟									
Compact cylinder, guide rod type		🐟									
Magnetically coupled rodless cylinder	🐟										
ISO standard 15552 air cylinder				🐟							
Rotary table rack & pinion type		🐟									

Electric actuators



Rod type, ball screw (230 VAC)
HF2A-LEY Series +

DELICER	VACCINATION	STUN AND BLEED	GUTTING	DESLIMER	GRADER	HEAD, FIN AND TAIL CUTTER	FILLET MACHINE	PIN-BONER	SKINNER	PORTIONING
	🐟		🐟		🐟		🐟	🐟	🐟	🐟

Directional control valves



Plug-in bottom ported manifold with stainless steel plate
JSY3000-S Series +



Clean design manifold valve
JSY5000-H Series +

🐟	🐟	🐟	🐟	🐟	🐟	🐟	🐟	🐟	🐟	🐟
🐟	🐟	🐟	🐟	🐟	🐟	🐟	🐟	🐟	🐟	🐟

Airline equipment



Air combination units for food & packaging
HF1-AC-D-X7000 Series +

🐟	🐟	🐟	🐟	🐟	🐟	🐟	🐟	🐟	🐟	🐟
---	---	---	---	---	---	---	---	---	---	---

Fittings



All-metal elbow speed controller with one-touch fitting and hexagon wrench adjusting & indicator
ASB-H Series +



Speed controller with one-touch fittings
HF1B-AS-F Series



Stainless steel throttle valve with one-touch fittings, in-line type, food compatible
HF2B-ASG-TV Series +



Wide angle blow nozzle
IN-225 Series +



Check valve
INA-14 Series +



Insert fitting, FDA compliant, EHEDG compliant, male connector
KFG2H-E Series +

	DELICER	VACCINATION	STUN AND BLEED	GUTTING	DESLIMER	GRADER	HEAD, FIN AND TAIL CUTTER	FILLET MACHINE	PIN-BOONER	SKINNER	PORTIONING
All-metal elbow speed controller with one-touch fitting and hexagon wrench adjusting & indicator (ASB-H Series)	🐟	🐟	🐟	🐟	🐟	🐟	🐟	🐟	🐟	🐟	🐟
Speed controller with one-touch fittings (HF1B-AS-F Series)	🐟	🐟	🐟	🐟		🐟	🐟	🐟	🐟	🐟	🐟
Stainless steel throttle valve with one-touch fittings, in-line type, food compatible (HF2B-ASG-TV Series)	🐟	🐟	🐟	🐟	🐟	🐟	🐟	🐟	🐟	🐟	🐟
Wide angle blow nozzle (IN-225 Series)				🐟	🐟		🐟	🐟	🐟	🐟	🐟
Check valve (INA-14 Series)		🐟									
Insert fitting, FDA compliant, EHEDG compliant, male connector (KFG2H-E Series)	🐟	🐟	🐟	🐟	🐟	🐟	🐟	🐟	🐟	🐟	🐟

Tubing



FDA and (EU) no 10/2011 compliant polyurethane tubing
TU-X214 Series +



Clean tubing, soft polyolefin
TPS Series +



Chemical and heat resistant
FEP tubing
TH Series +

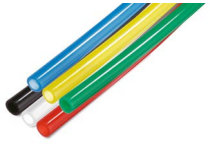

Polyethylene tubing
TX Series +

	DELICER	VACCINATION	STUN AND BLEED	GUTTING	DESLIMER	GRADER	HEAD, FIN AND TAIL CUTTER	FILLET MACHINE	PIN-BOONER	SKINNER	PORTIONING
FDA and (EU) no 10/2011 compliant polyurethane tubing TU-X214 Series +	✓	✓	✓	✓	✓	✓	✓	✓	✓	✓	✓
Clean tubing, soft polyolefin TPS Series +	✓	✓	✓	✓	✓	✓	✓	✓	✓	✓	✓
Chemical and heat resistant FEP tubing TH Series +	✓	✓	✓	✓	✓	✓	✓	✓	✓	✓	✓
Polyethylene tubing TX Series +	✓	✓	✓	✓	✓	✓	✓	✓	✓	✓	✓

Fluid control equipment



Direct operated 2-port solenoid valve
HF1B-JSX Series +

DELICER	VACCINATION	STUN AND BLEED	GUTTING	DESLIMER	GRADER	HEAD, FIN AND TAIL CUTTER	FILLET MACHINE	PIN-BONER	SKINNER	PORTIONING
	🐟	🐟	🐟	🐟			🐟	🐟	🐟	🐟

Sensors & Switches



Electro-pneumatic regulator/
electronic vacuum regulator
ITV Series +



Modular digital flow switch
PF3A8□H Series +



Clamp-on type flow sensor for liquids
PFUW Series +

			🐟				🐟	🐟	🐟	
🐟	🐟	🐟	🐟		🐟	🐟	🐟	🐟	🐟	🐟
🐟	🐟		🐟	🐟		🐟	🐟	🐟	🐟	🐟

We understand your process requirements

At SMC, we understand the complex regulatory landscape of the protein industry. We specialise in providing comprehensive support, ensuring your selection of key products and equipment aligns with both compliance and operational efficiency.

We believe these focus areas are paramount for you and your customers, and we are committed to working closely with your team to guarantee the right equipment selection.

[+ Discover more](#)

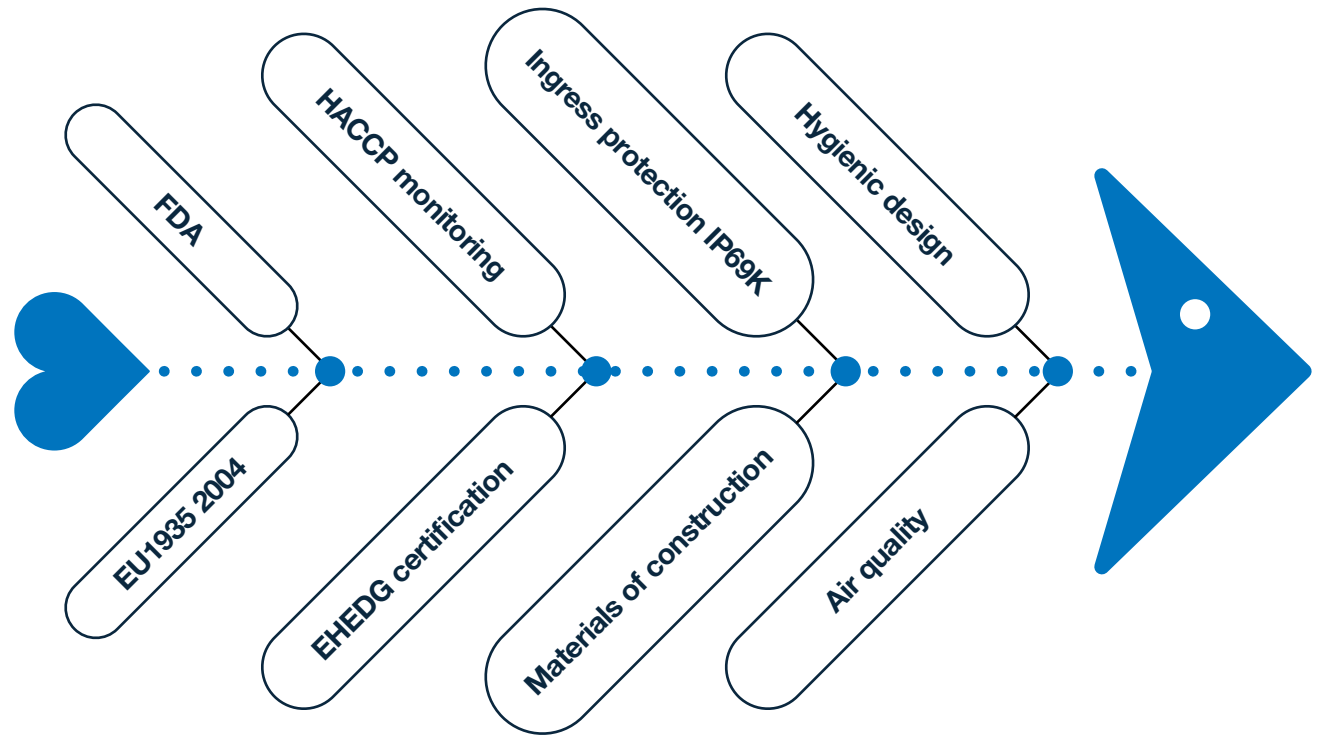

One-stop shop

As a global market leader, SMC responds to customer expectations for convenience and efficiency with extensive product range for one-stop shop experience.

Leave it to SMC



12,000 basic models
and **700,000** variations

**A wide range of product
variations to accommodate
various applications**

Our support network

SMC's worldwide commitment

One of the things we do best at SMC is **being close to our customers**. Local support, on a global scale.

With support in over **500 locations** across **80 countries** and regions **worldwide**, our sales force of **7000 experts** maintains **close communication with customers**.

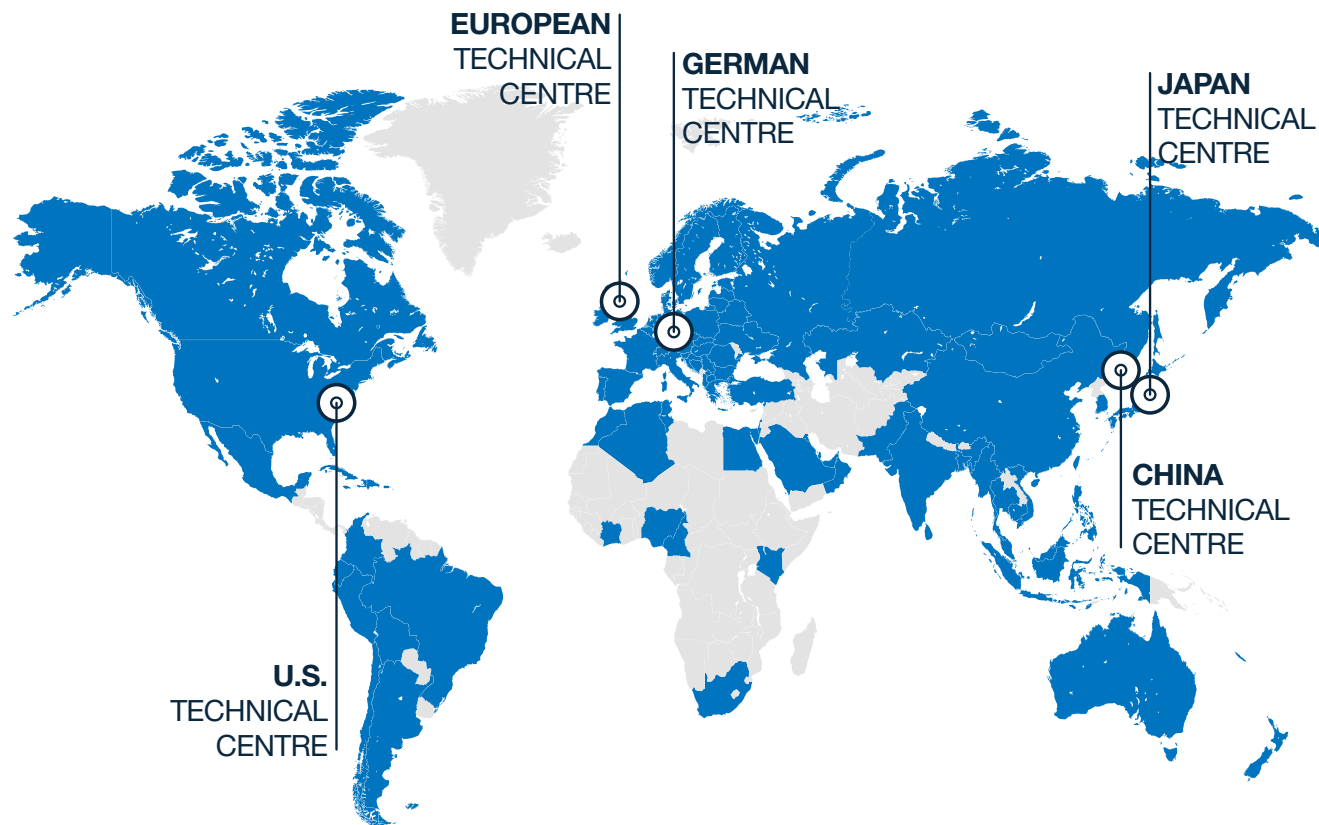

SMC Business Continuity Plan

Sustainable growth also means ensuring uninterrupted operations

We are committed to ensuring that SMC is prepared for any emergency and that our business activities will not stop in the event of such circumstances. SMC aims to fulfil our product supply responsibilities and maintain our customers' trust by contributing to both sustainable growth and the expansion of technological innovations.

SMC, as a comprehensive manufacturer of automatic control equipment that supports automation, is able to promptly provide products that meet our customers' needs anywhere in the world.

Production BCP

Ensure customer order fulfilment

Reliable delivery for you thanks to our 9 global logistic centres and 38 production sites worldwide. Moreover, flexibility to rapidly respond to any sudden change in the manufacturing environment.

Finance BCP

Safe & Solid financial base

In the event of an emergency, SMC can provide a safe and solid financial base (with cash, deposits, and equity capital) that will sufficiently cover the working capital and funds needed to rebuild buildings and the equipment required for business continuity. This is done to provide peace of mind to our customers and workers alike.

Information security BCP

Vital data kept safe

Strengthen information security for protection against computer viruses and cyberattacks, plus the installation of data centres to establish a disaster recovery system. Your information is safe with us.

Engineering BCP

Consistent technical support

2,000 engineers at our 5 technical centres around the globe.

Sales BCP

Consistent sales support

7,000 sales engineers worldwide ready to recommend the best solution for you. Over 80 global locations to make sure that wherever you are, we are there too.

[+ Discover more](#)



SMC Corporation

1-5-5, Kyobashi,
Chuo-ku, Tokyo
104-0031, Japan
Telephone: 03-6628-3000
<https://www.smcworld.com>

Austria	+43 (0)2262622800	www.smc.at	office.at@smc.com						
Belgium	+32 (0)33551464	www.smc.be	info@smc.be						
Bulgaria	+359 (0)2807670	www.smc.bg	sales.bg@smc.com						
Croatia	+385 (0)13707288	www.smc.hr	sales.hr@smc.com						
Czech Republic	+420 541424611	www.smc.cz	office.at@smc.com						
Denmark	+45 70252900	www.smc.dk.com	smc.dk@smc.com						
Estonia	+372 651 0370	www.smcee.ee	info.ee@smc.com						
Finland	+358 207513513	www.smc.fi	smc.fi@smc.com						
France	+33 (0)164761000	www.smc-france.fr	supportclient.fr@smc.com						
Germany	+49 (0)61034020	www.smc.de	info.de@smc.com						
Greece	+30 210 2717265	www.smchellas.gr	sales@smchellas.gr						
Hungary	+36 23513000	www.smc.hu	office.hu@smc.com						
Ireland	+353 (0)14039000	www.smcautomation.ie	technical.ie@smc.com						
Italy	+39 03990691	www.smcitalia.it	mailbox.it@smc.com						
Latvia	+371 67817700	www.smc.lv	info.lv@smc.com						
Lithuania	+370 5 2308118	www.smclt.lt	info.lt@smc.com						
Netherlands	+31 (0)205318888	www.smc.nl	info@smc.nl						
Norway	+47 67129020	www.smc-norge.no	post.no@smc.com						
Poland	+48 22 344 40 00	www.smc.pl	office.pl@smc.com						
Portugal	+351 214724500	www.smc.eu	apoiocliente.pt@smc.com						
Romania	+40 213205111	www.smcromania.ro	office.ro@smc.com						
Russia	+7 (812)3036600	www.smc.eu	sales@smcru.com						
Slovakia	+421 (0)413213212	www.smc.sk	sales.sk@smc.com						
Slovenia	+386 (0)73885412	www.smc.si	office.si@smc.com						
Spain	+34 945184100	www.smc.eu	post.es@smc.com						
Sweden	+46 (0)86031240	www.smc.nu	order.se@smc.com						
Switzerland	+41 (0)523963131	www.smc.ch	helpcenter.ch@smc.com						
Turkey	+90 212 489 0 440	www.smcturkey.com.tr	satis.tr@smc.com						
UK	+44 (0)845 121 5122	www.smc.uk	sales.gb@smc.com						
South Africa	+27 10 900 1233	www.smcza.co.za	Sales.za@smc.com						

www.smc.eu

Release EQ
SEAF-01A-EN

SPECIFICATIONS ARE SUBJECT TO CHANGE WITHOUT PRIOR NOTICE AND ANY OBLIGATION ON THE PART OF THE MANUFACTURER