



**ROBOTICS SOLUTIONS**

# Your right arm

USE ROBOTICS TO TAKE A FIRM GRIP  
ON PRODUCTION FLEXIBILITY



Expertise  
Passion  
Automation

# Your robotic partner

---

## SMC can be your global robotics supplier

### Industrial robots are no replacement for human creativity

Industrial robot adoption is growing at 15 % annually (Source: IFR), with over 4 million expected in factories by 2024. Europe leads this shift, boasting a robot density of 219 units per 10,000 workers, reinforcing its commitment to competitiveness. Despite automation's rise, robots – industrial or collaborative – cannot replace human ingenuity. Strategic thinking, creativity, and attention to detail remain uniquely human strengths. Today, humans and robots work together, driving both innovation and efficiency.

### The era of collaborative robots

Cobots are reshaping manufacturing, enhancing productivity while ensuring precision, adaptability, and safety. By 2025, the global cobot market is projected to exceed €3 billion.

The European Union's Horizon Europe program, running until 2027 with a budget of EUR 95.5 billion, focuses on strengthening scientific and technological leadership. Robotics-related funding of EUR 174 million supports AI, data, automation, and clean energy initiatives.

Europe continues to prioritize automation while ensuring human expertise remains central to technological progress.

---

**Discover SMC's innovative, energy-efficient, and lightweight solutions for industrial and collaborative robotics, and see how we can be your right arm in automation.**

---





# Key solutions

## SMC

- Collaboration 
- Gripper changing systems 
- Industrial communication 
- Speed 
- Endurance 
- Miniature 



## SMC's key solutions for robotics: driving efficiency and innovation

At SMC, we empower industrial and collaborative robotics with cutting-edge solutions designed to **enhance performance, flexibility, and sustainability**. With a focus on innovation, we provide technologies that meet the unique demands of automation in modern industries.

---

**Are you looking for a complete robotics solution provider?**

**SMC matches your needs and eases a complete system design.**

---

# Collaboration

## Empowering human-robot synergy

Collaborative robots (cobots) are revolutionising the way humans and machines work together, combining safety, precision, and flexibility to tackle complex tasks. At SMC, we provide innovative components specifically designed for cobot applications, from **lightweight grippers, electric or pneumatic, vacuum handling solutions and innovative magnetic grippers.**

Our solutions enhance cobot performance with energy-efficient designs, easy integration, and quick EOAT exchange capabilities, enabling seamless adaptation to ever-changing industrial demands. With SMC as your partner, you gain access to cutting-edge technologies and global support, making us “**Your right arm**” in collaborative automation.

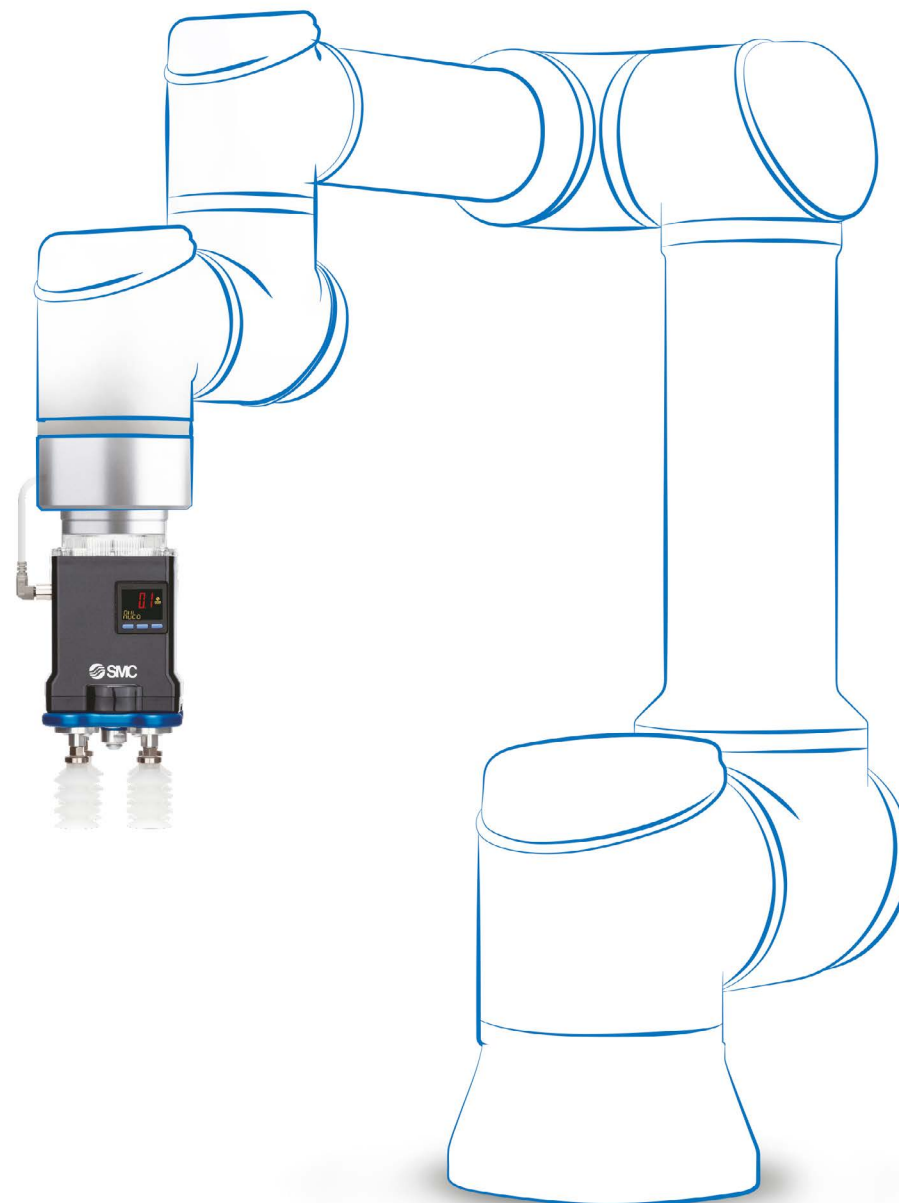
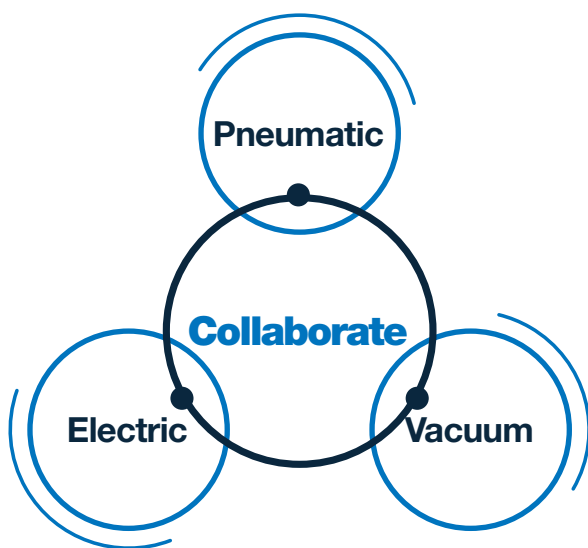

## Pneumatic gripping

### Collaborate and work smarter

- Certified for use with leading collaborative robot manufacturers, including UNIVERSAL ROBOTS, OMRON/TECHMAN ROBOT, FANUC, YASKAWA, Mitsubishi Electric, KUKA, DOOSAN, and ABB, among others.
- Plug & Play configuration for UNIVERSAL ROBOTS, OMRON/TECHMAN ROBOT, FANUC, and YASKAWA, installation is quick and simple, requiring only one air supply tube and one electrical wire. Conform to ISO 9409-1-50-4-M6 standards.
- Three designs with gripping forces of up to 130 N and repeatability of  $\pm 0.01$  mm.
- Cost-efficient with integrated solenoid valves, they save up to 80 % air consumption compared to external setups.
- Additional features include a split protective cover for enhanced safety and durability.

### 2 finger standard: Up to 72.2 N



### 3 finger gripper: Up to 130 N



### 2 finger long stroke: Up to 90 N



## Electric gripping

### Electrify collaboration, elevate efficiency

- Certified for use with leading collaborative robot manufacturers: UNIVERSAL ROBOTS, FANUC and OMRON/TECHMAN ROBOT.
- Plug & Play configuration, installation is quick and hassle-free, requiring only one M8 cable. The grippers conform to ISO 9409-1-50-4-M6 standards.
- These grippers deliver gripping forces ranging from 60 to 140 N, with a repeatability of  $\pm 0.1$  mm, ensuring precision and reliability. Self-locking mechanism using a slide screw drive prevents drop accidents without requiring energy.
- Battery-less absolute encoder resumes finger movement from the last position, eliminating the need to return to home and reducing downtime.

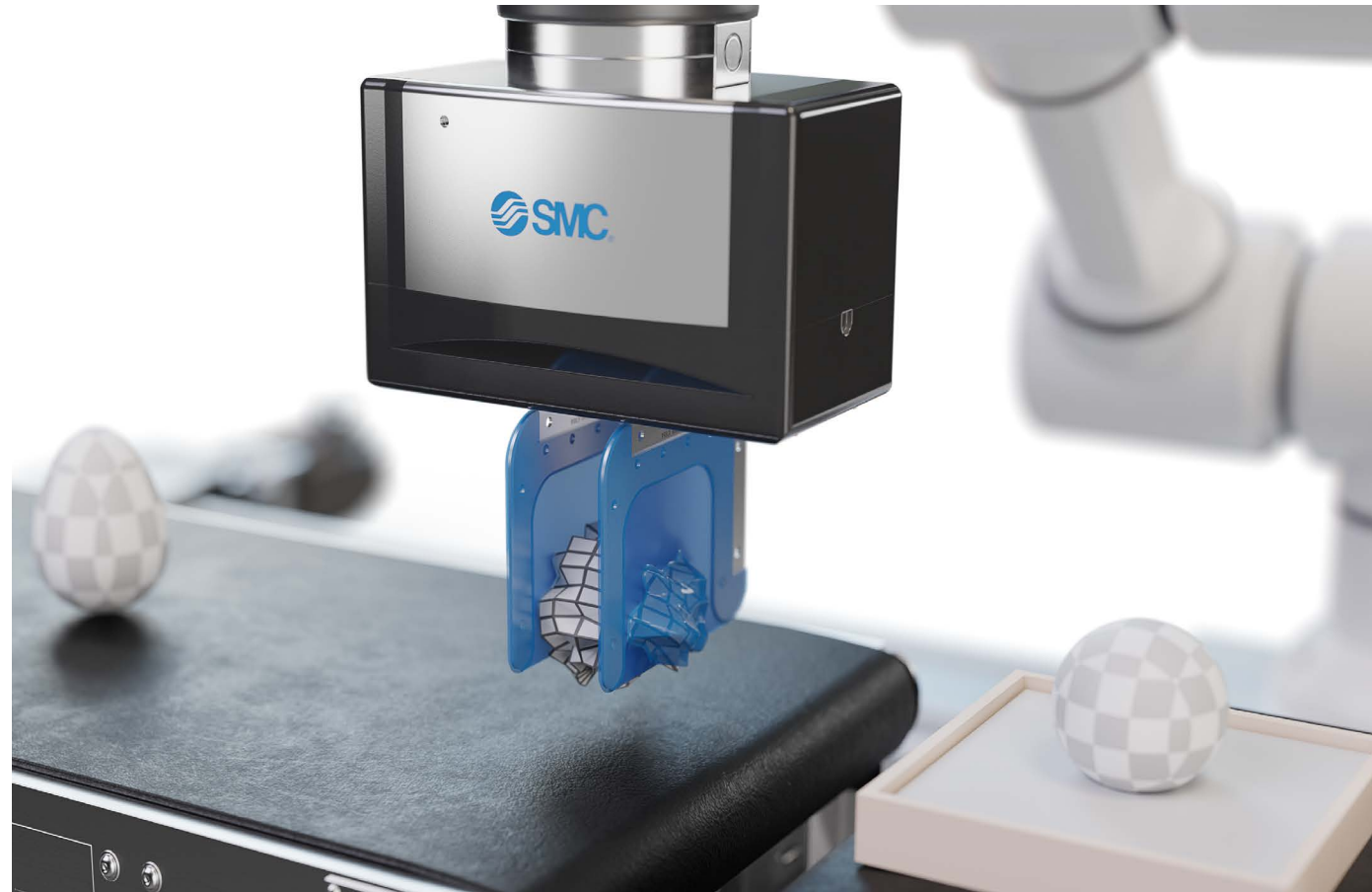

## Vacuum gripping

### Ease your cobot's vacuum handling

- Designed for seamless integration with collaborative robots from leading manufacturers, including UNIVERSAL ROBOTS, OMRON/TECHMAN ROBOT, FANUC, YASKAWA, Mitsubishi Electric, Kawasaki, and Kawada Robotics.
- Plug & Play configuration, it minimizes mounting tasks and setup time, requiring only one compressed air supply tube and an electrical wiring connector for operation.
- The gripper features an integrated vacuum ejector, air supply/release valve, pressure sensor, and pads, delivering an all-in-one solution. It offers flexible handling with customizable pad configurations, shapes, and materials, supporting a maximum workload of 7 kg, a suction flow rate of 17 l/min (ANR), and a vacuum pressure of -84 Pa.
- Compliant with ISO 9409-1-50-4-M6 and ISO 9409-1-31.5-4-M5 standards.



## Vacuum gripping

### Pump your collaboration

- Simplifies collaborative robot integration by combining the vacuum pump, atmospheric release valve, pressure monitor, and suction cups into a single, compact solution. Installation is quick and straightforward with an M8 connector, while compliance with ISO 9409-1-50-4-M6 enables easy tool changes with just two clamber bolts.
- Compatible with leading manufacturers, UNIVERSAL ROBOTS, FANUC, YASKAWA, and OMRON/TECHMAN ROBOT.
- Enhanced process control with a 360° visual indicator and a diagnosis function that monitors vacuum pressure and system settings for optimal performance. Additionally, three operation modes optimize power consumption, helping to reduce costs and improve energy efficiency.





# Magnetic gripping

## Performs optimally, where others don't

- Suitable for use in collaborative robots – Magnetic gripper unit with integrated solenoid valve and speed adjustment mechanism
- Reduce your setup time – Plug and Play configuration for immediate use in a collaborative robot
- Handle with reliability and safety – Holding force up to 200 N plus it guarantees grasping of the workpiece even when the air is shut off.
- Compatible manufacturers: UNIVERSAL ROBOTS, OMRON/TECHMAN ROBOT, Mitsubishi Electric, YASKAWA and FANUC
- Integrated solenoid valve, speed adjustment mechanism, and auto switch
- Operate by simply connecting 1 air supply tube and an electrical wiring M8 or M12 connector
- Holding force can be adjusted
- Compliant with ISO 9409-1-50-4-M6.





## The complete and efficient palletising solution

### + ZGS: The complete and efficient palletising solution

Simplify your palletising process with SMC's ZGS, a fully integrated vacuum gripper designed for maximum efficiency and ease of use.

Reduce installation and design time with a unit that combines all essential peripherals – ejector assembly, foam, supply valve, release valve, and pressure switch – into one compact solution. Its slim and lightweight design allows for robot downsizing, optimising dimensions and reducing energy use.

Achieve unmatched productivity with adjustable suction flow, enabling efficient handling of workpieces of various shapes and sizes. The ZGS ensures a secure grip in any orientation, regardless of the contact area, making it ideal for diverse applications.

UR+ certified and compatible with industrial and collaborative robots like UNIVERSAL ROBOTS, OMRON/TECHMAN ROBOT, FANUC, and YASKAWA, the ZGS offers seamless integration with minimal setup – just connect an M8 connector and supply air.

Foam size: 200 x 120 mm, 300 x 180 mm, 400 x 240 mm

Applications: packaging, palletising, and beyond.



**Experience the ZGS  
and elevate your robotic  
palletising operations today!**

# Gripper changing systems

SMC's automatic and manual changers are compatible with a wide range of robotic arms, offering secure locking mechanisms and simple integration for both collaborative and industrial robots. Whether for assembly, material handling, or pick-and-place operations, our products offer flexibility, and reliability.



## Multi hand adapter + RMMA Series

- **Increased efficiency** – 1 robot can undertake up to 3 handling tasks
- **Improve flexibility** – Various workpiece types can be handled in the same process
- **Maximise uptime** – Quick and simple automated tool change
- **Facilitate combinations** – Mounting angles can be selected according to application requirements.

A wide range of combinations is possible. Mounting angles can be selected according to the specifications.

90°



180°

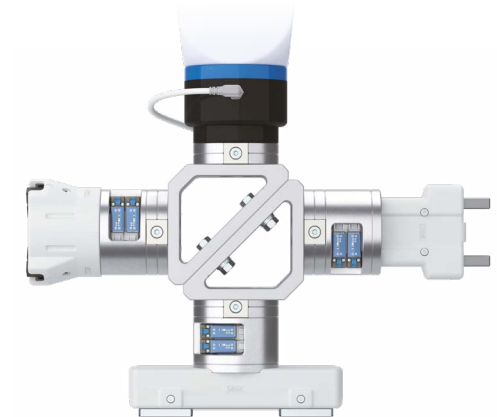



## Auto tool changer RMTA Series

### Automatic tool changer

- **Enhanced efficiency** – Supports a workload of up to 20 kg, allowing for robust handling tasks
- **Increased flexibility** – Direct mounting on collaborative robots eliminates the need for flanges, reducing design labour
- **Maximised uptime** – Features a drop prevention mechanism that locks the actuator, ensuring parts remain secure even if air pressure drops
- **Facilitated combinations** – High precision and rigidity with repeatability of  $\pm 0.01$  mm.

## The robot adapter enables mounting to a wide range of robots

Can also be used with the tool changer on shaft-mounted SCARA robots or robots with different flange mounting dimensions.

### Robot adapter for shaft mounting

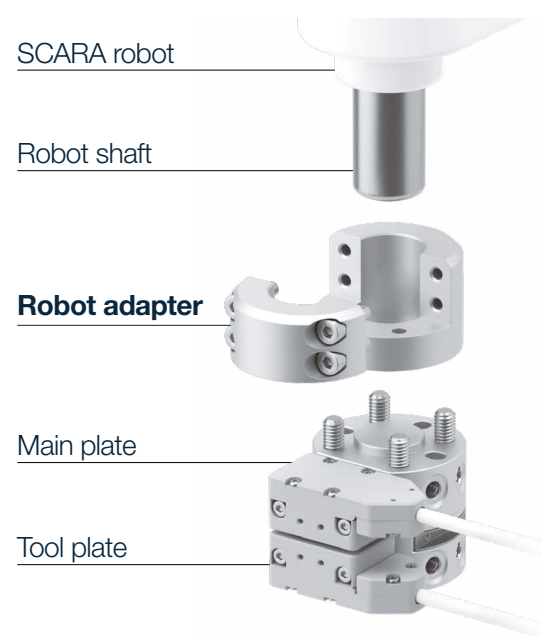

### Robot adapter for flange mounting

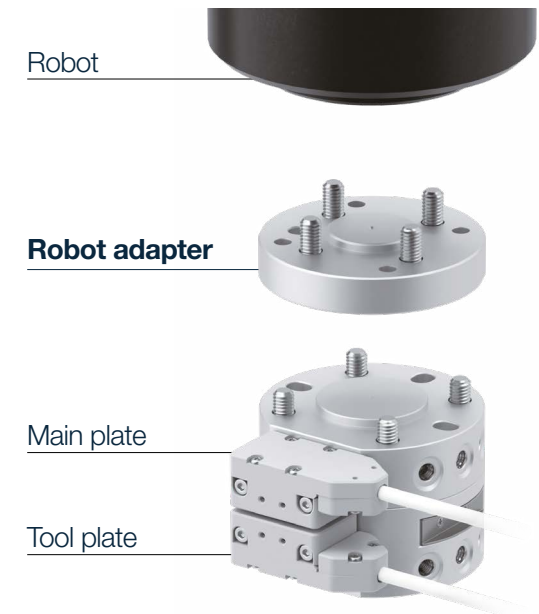



## Manual tool changer RMTM Series

### Automatic tool changer

- **Enhanced efficiency** – Supports a workload of up to 20 kg, allowing for robust handling tasks
- **Increased flexibility** – Direct mounting on collaborative robots eliminates the need for flanges, reducing design labour
- **Maximised uptime** – Features a drop prevention mechanism that locks the actuator, ensuring parts remain secure even if air pressure drops
- **Facilitated combinations** – High precision and rigidity with repeatability of  $\pm 0.01$  mm.

### One-push type

Tools can be attached/removed by the push of a button (no tools required).

- Work load: 10 kg
- Repeatability:  $\pm 0.01$  (Position reproducibility).

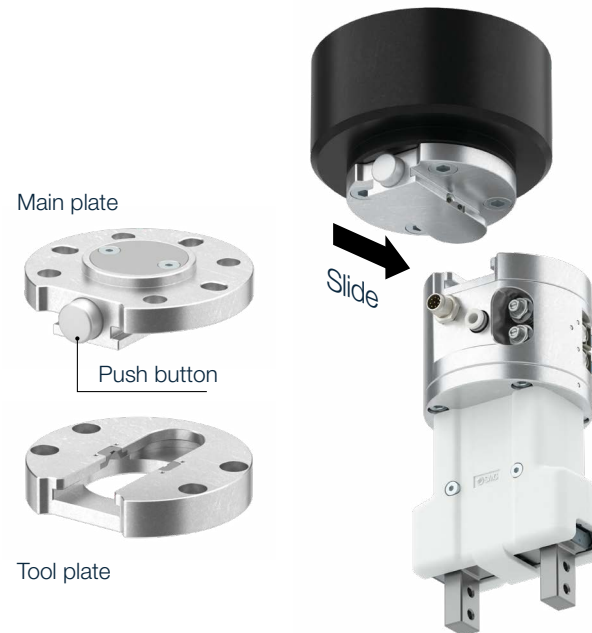

### Clamp type

Tools can be attached/removed by clamber bolts (2 pcs).

- Work load: 20 kg
- Repeatability:  $\pm 0.02$  (Position reproducibility).

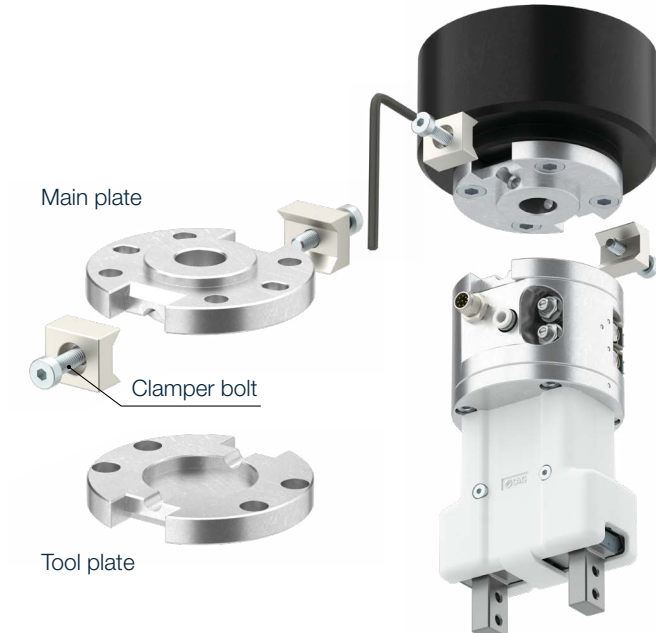



## Gripper accessories

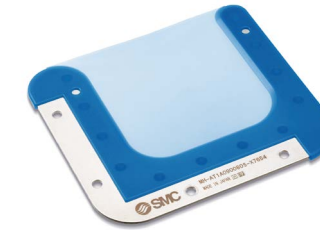
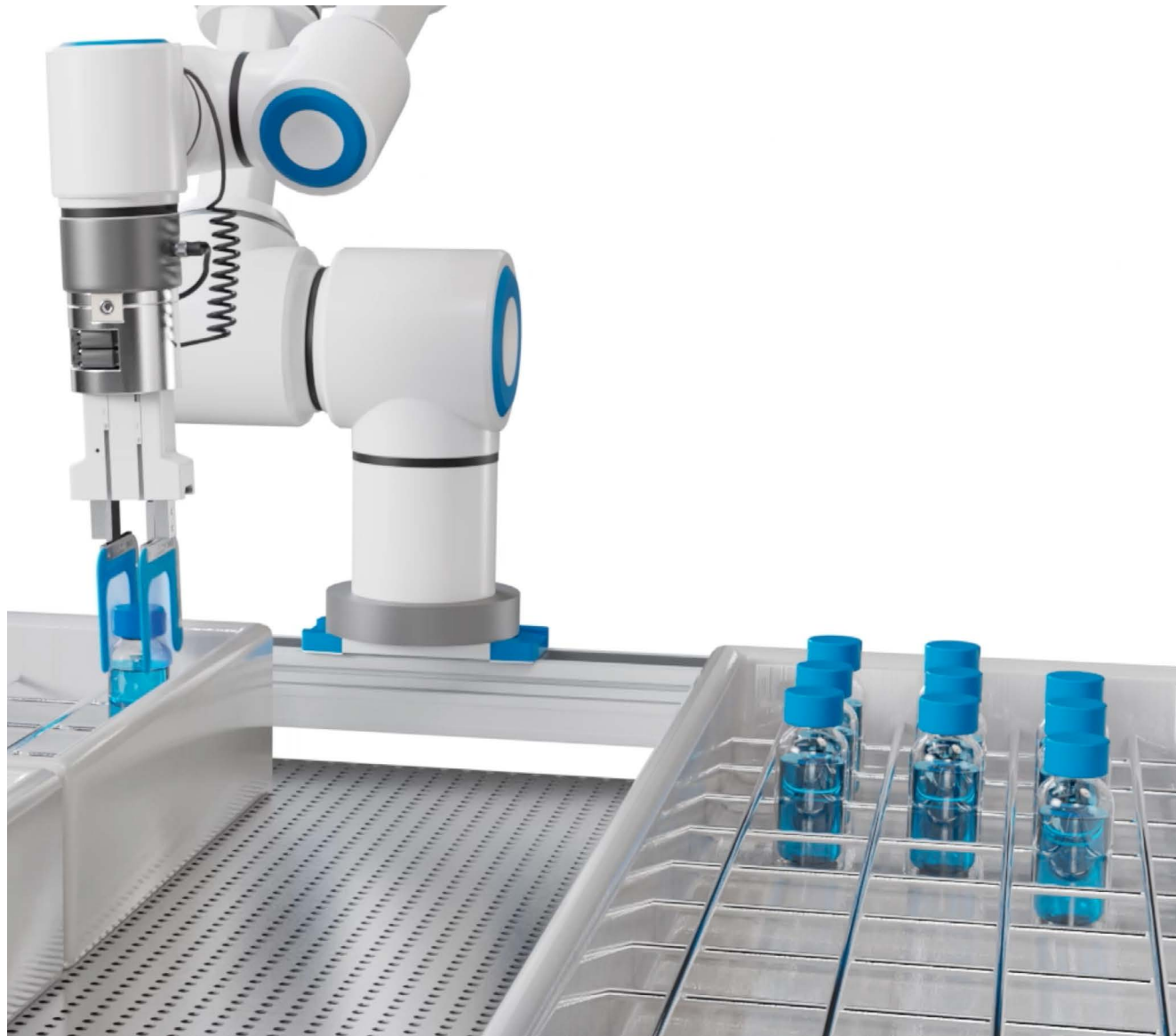

### Elastic fingers for grippers

#### + MH-X7654 Series

- **Versatile and adaptable** – Advanced elastic materials and different finger options (EPDM and FDA-compliant silicone rubber) suit various applications
- **Flexible and efficient** – Slim design (as narrow as 3 mm), effective gripping surface (40 x 40 mm, 58 x 60 mm, and 80 x 80 mm), and dual mounting options for optimal application fit.



### Electric actuators

#### + LE Series

- **Improved efficiency** – Integrated controllers and battery-less absolute encoders reduce setup time and maintenance
- **Versatile performance** – Suitable for a wide range of tasks, from simple positioning to complex multi-axis systems
- **Robust design** – Built to withstand demanding industrial environments with options for dust-tight and water-jet-proof models.



## Compact compressor

### + CRP Series

- **Versatile pressure generation** – Supplies compressed air or vacuum in environments without an air source
- **Enhanced performance** – Compact and lightweight design allows for easy installation in moving robots
- **Low maintenance** – Oil-free reciprocating compressor eliminates the need for daily upkeep
- **Quiet operation** – Operates at noise levels as low as 55 dB, suitable for quiet areas.

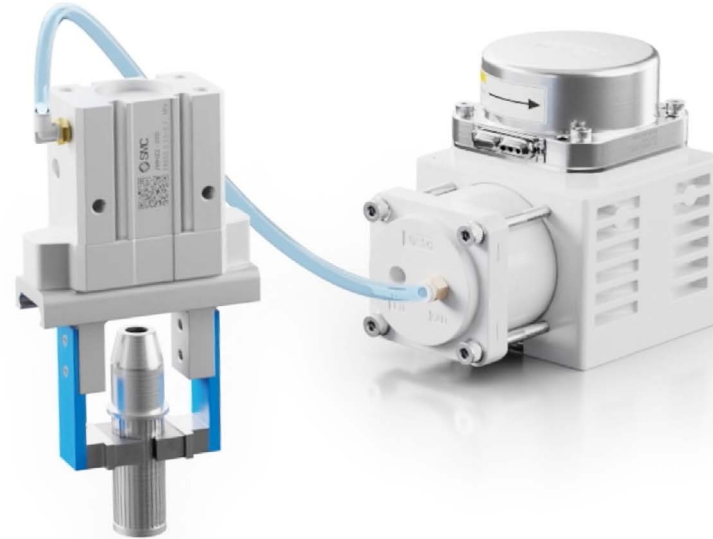

# Industrial communication

## Disconnect from mainstream solutions

In today's manufacturing, machines and devices communicate with each other and can be controlled remotely, being connected thanks to sensors and communication technologies. This is what is known as Smart Connectivity. This is, for example, essential to the well-known industrial maintenance of any production process.

That's why, at SMC we're helping our customers go towards **Smart Manufacturing**. We help our customers to improve the efficiency and productivity of their processes by combining the advantages of **industrial communication solutions** with the ability to understand their needs. This allows us to tailor our solutions to achieve the best customer value, while assuring global availability and supply, always ensuring that effective production continues.

## Wireless

**Less cabling. Less installation time. Less downtime. Less hassle.**

- Protocols: PROFINET, EtherNet/IP™, CC-Link, EtherCAT®
- Possibility to combine modular and compact systems
- Communication distance: up to 100 m
- Applicable valve series: JSY, new SY, VQC, S0700, SV
- Up to 9 input / output / IO-Link master units
- Up to 1280 inputs / 1280 outputs
- Up to IP67 enclosure.



**Modular wireless system**  
+ EX600 Series



**Compact wireless system**  
+ EXW1 Series



## + Fieldbus unit for input/output

### Increase the capabilities of your communications

- Protocols: IO-Link, EtherNet/IP™, DeviceNet™, CC-Link, PROFINET, PROFIBUS, Modbus/TCP, POWERLINK
- Up to 128 solenoids, 64 stations
- Applicable valve series: JSY, new SY, VQC, S0700, SV
- Up to 9 input / output / IO-Link units
- Up to 1280 inputs / 1280 outputs
- Up to IP67 enclosure.



## + Compact fieldbus system for output

### The cost-effective solution for your communications

- Compatible protocols: PROFI-safe, Ethernet POWERLINK, PROFINET, EtherNet/IP™, EtherCAT®, PROFIBUS DP, DeviceNet™, CC-Link, IO-Link, Modbus, AS-Interface
- Up to 32 solenoids, up to 24 stations
- Applicable valve series: JSY, new SY, VQC, S0700, SV
- Up to IP67 enclosure.



# Speed

## Let your robot move faster; push your productivity

Are you ready to enhance your robot's performance? SMC offers a range of innovative solutions designed to make your robots move faster and more efficiently. Our advanced automation components are perfect for optimizing your robotic systems, providing quick and easy tool changes, and reducing overall cycle times.

With SMC's cutting-edge technology, you can achieve faster, more flexible, and highly productive robotic operations. Experience the difference with SMC's solutions!



### 5-port solenoid valve

#### + JSY Series

- **Save space** – The thinnest valve in the world: 6.4 mm that will provide you a great flow of 244 l/min
- **Increase your productivity** – Reduce cycle times considerably
- **Endorse Energy Efficiency and keep cool** – Power saver provides a minim 0.1 W and prevents from heating up
- **Adapt to your specific needs** – Flexible piping and any electrical connection with plug-in. Bottom or side ported with non-plug-in.



### Cylinders

#### + JCQ/JMGP/JCM/JMB Series

- **Suitable for robot manipulation** – Up to 69 % lighter with overall length shortened. Improved cycle times
- **Better utilisation** – Compact, guide, tie-rod and round types. Tie-rod type allows intermediate bore sizes for an even greater optimisation.



### Parallel style air gripper

#### + JMHZ2 Series

- **Minimise the moments of inertia in your robot** – Overall length shortened up to 21 % <sup>1)</sup> and weight reduced up to 43 % <sup>1)</sup>
- **Enhance your performance** – Higher opening/closing stroke and longer gripping point is possible in cylinder one bore smaller
- **Achieve precise handling** – Precision repeatability as low as  $\pm 0.01$  mm.

<sup>1)</sup> All comparisons are done with alike models in the market.



### Speed controller with one-touch fitting

#### + JAS Series

- **Suitable for confined spaces** – Height reduction up to 43.3 %
- **Easy to install and easy to operate** – Needle adjustment by manual push-lock or with a flat blade screwdriver.

# Endurance

SMC's products for robotics are built to deliver exceptional endurance, ensuring reliable performance in the most **demanding robotic applications**. Designed with high-quality materials and precision engineering, our components are tested to **withstand continuous operation, heavy workloads, and harsh industrial environments**. Features like wear-resistant materials and robust construction ensure long-lasting durability and minimal maintenance.

Whether operating at high speeds, in repetitive tasks, or under extreme conditions, **SMC solutions guarantee consistent performance, making them a trusted choice for enhancing the longevity and efficiency of robotic systems.**



## Wear-resistant tubing

### + TUZ Series

- **Avoid sliding motion abrasion with this special polyurethane tubing**
- **Be sure it will last** – Maximum abrasion 0.16 mm after 10 million cycles
- **Fit it in narrow piping spaces** – Small bending radius.



## Rotary joint

### + MQR Series

- **Prevent machine stops due to tube wear** – Connect pneumatic circuits from a stationary inlet to a rotating outlet
- **Choose which best suits you** – 1 to 16 circuits available, as well as metal & rubber seal
- **Reduce your labour time** – Piping ports are aligned in spiral line.



## Rotary one-touch fittings

### + KS/KX Series

- **Ideal for oscillating or rotating sections in robots** – Ball race bearing
- **Eliminate wear at fitting and tubing** – Tube rotation prevention mechanism
- **Specific version for high-speed applications (KX Series).**



## Longer life cylinders

### + MGP/CQ2/CM2/MGJ-X24 Series

- **Low-maintenance, high durability** – 4 times the durability of standard versions, reaching up to 50 million cycles
- **Easy Interchangeability** – With the same dimensions and specifications as standard cylinders
- **Reliable in dusty environments** – Engineered for performance in challenging conditions.

# Miniature

## The space saving 3-in-1 electric solution your robot needed

Miniaturisation is a key factor to increasing the productivity of your robot application and that is why we have designed an **ultra-compact solution** integrating a linear motor, a linear guide and a displacement sensor.



### Card motor

#### + LAT3 Series

- **Transport, push or measure length with this miniaturised linear motor**
- **Place it virtually anywhere** – The size of a credit card & 9 mm high
- **Secure your cycle times** – High-speed response and operation.

# Gripping

## Don't lose your grip!

Elevate your automation with SMC's advanced gripping solutions – whether pneumatic, electric, or tailored for collaborative robots. Designed for precision, flexibility, and reliability, SMC empowers your robots to handle any task with ease, pushing the limits of what's possible in automation.



### Pneumatic grippers

#### + MH Series

- **Pick up whatever** – Available in parallel style with 2, 3 and 4 fingers, in angular style
- **Mount them wherever, however** – High degree of mounting flexibility plus a variety of dust covers
- **Achieve precise handling** – Precision repeatability as low as  $\pm 0.01$  mm.

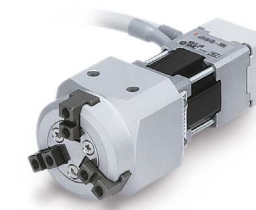
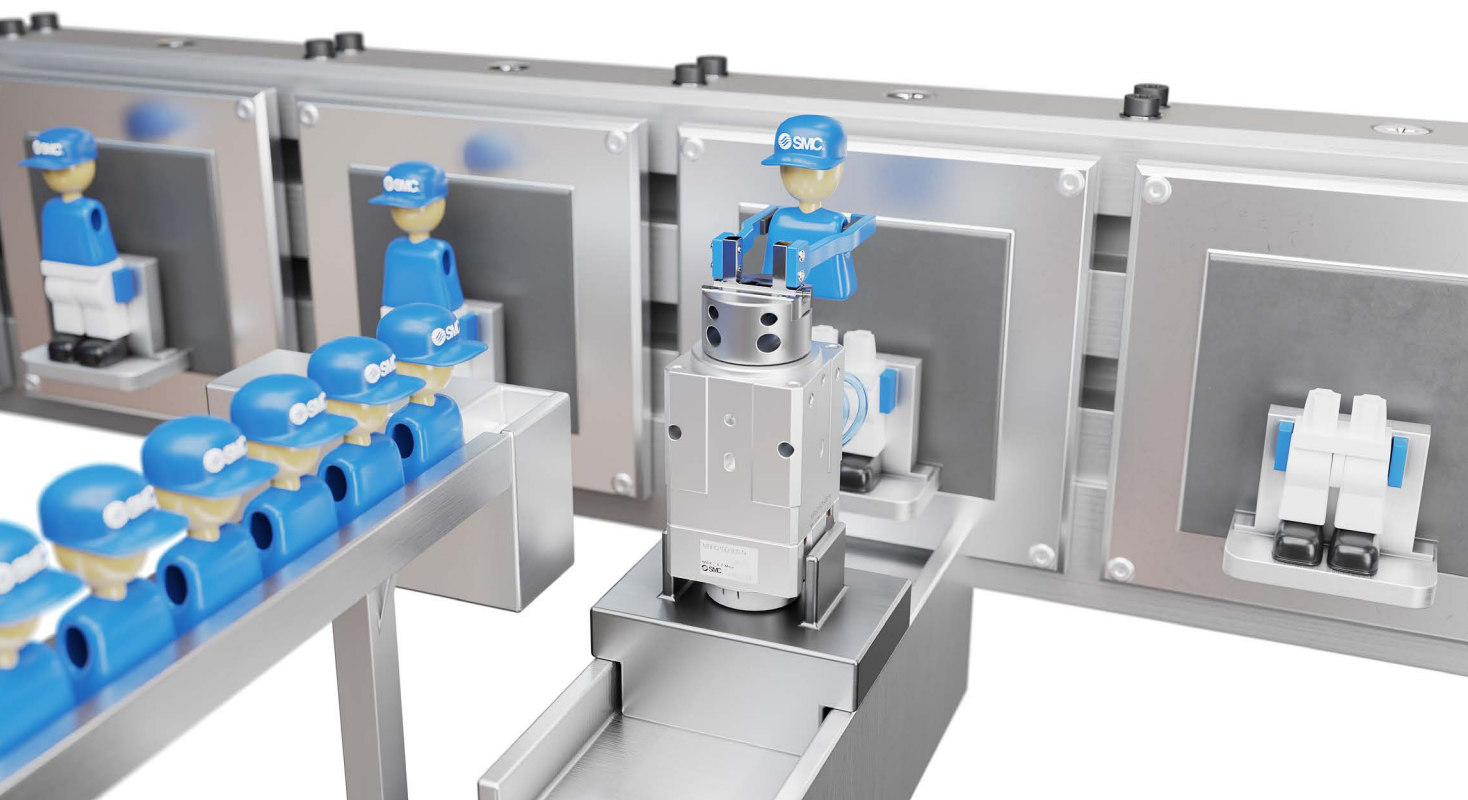

### Electric grippers

#### + LEH Series

- **Great variety of mechanics to choose from** – Tailored electrical solution
- **Total speed, force & position control** – Digital I/Os or fieldbus commands, including IO-Link
- **Ensuring you grip what you need to** – Gripping check function to identify workpieces with different dimensions
- **Always with safety in mind** – Workpiece drop prevention function.





## Magnetic gripper

### + MHM Series

- **Performs optimally, where others don't** – Holds ferromagnetic workpieces with holes and uneven surfaces
- **Handle with reliability and safety** – Holding force up to 120 N, plus it guarantees gripping the workpiece even when the air is shut off
- **Increase your productivity** – Reduce your cycle times.



## Compact, wedge cam

### + MHS Series

- **Mount our 3-finger air grippers on the reversing unit to operate in limited spaces** – Reduction of the turning diameter required by mounting the air grippers in parallel
- **Downsize your machines** – The stroke of the equipment shutters can be reduced.



## Air gripper with finger changer function

### MHF2-X7076A Series

- **Downsize your application** – The wiring and piping are bundled together in the body of the air gripper
- **Enhance your performance** – Improves electric contact during tool changes and reduce air leakage due to defective piping connections.

# Vacuum handling

## Time to get a grip on efficiency

SMC supports you throughout the vacuum system, from the filtration and regulation to the End of Arm Tooling (EOAT), trying to offer the most **efficient and energy-saving solution** possible, while giving high performance and reliability. As a complete supplier of automation, we offer **unique solutions** in the market: valve and ejector combined manifold, wireless system, cylinder with vacuum pad, air amplifier, etc.

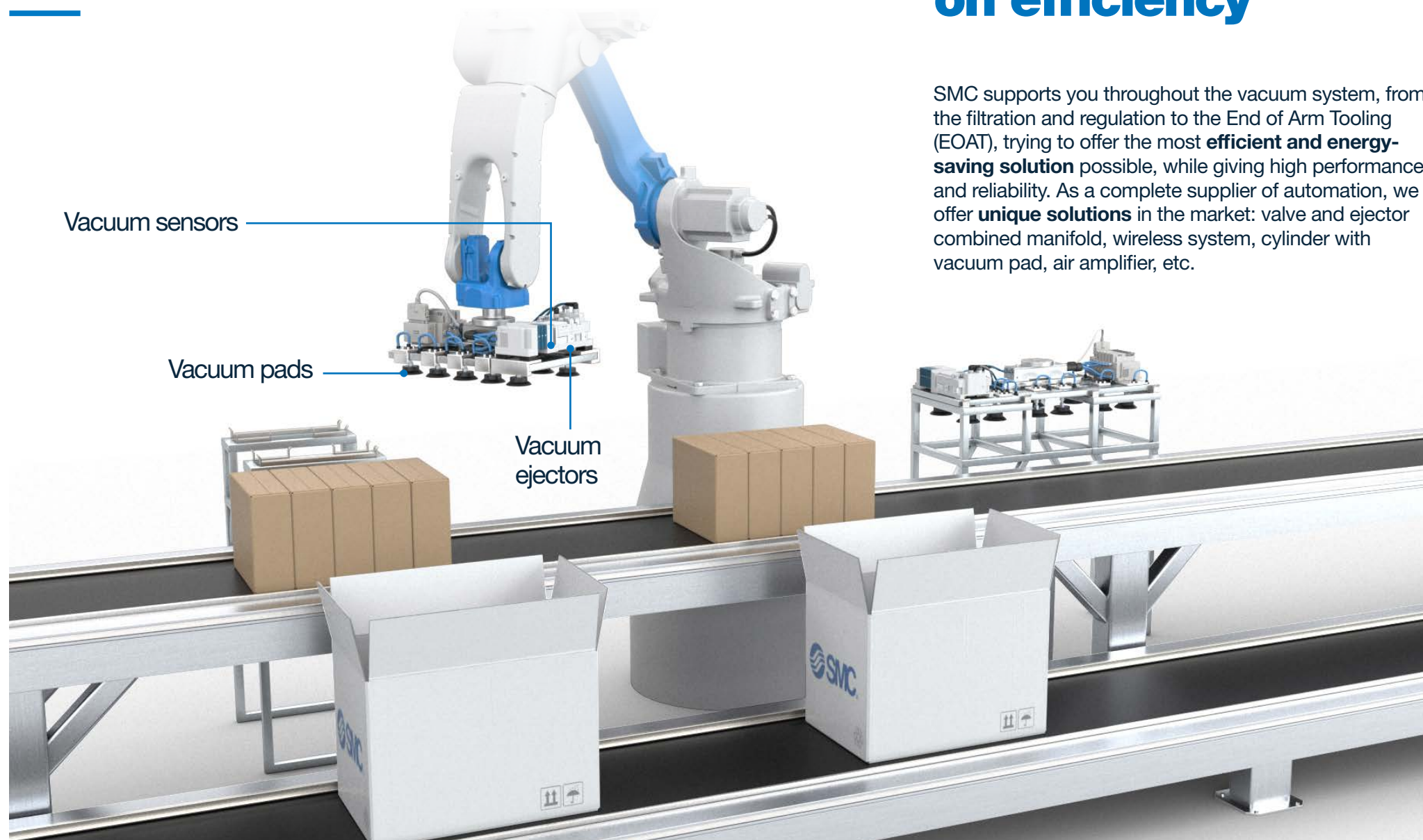

# Vacuum pads

Explore SMC's comprehensive range of vacuum pads, designed to meet every application need. **From food-compatible pads for safe and hygienic handling, to general-use pads for versatile tasks, and high-durability pads built for demanding environments.** Discover our non-contact pads for delicate or porous workpieces and vacuum pads with integrated ejectors for compact, energy-efficient performance. Whatever your handling challenge, SMC has the perfect solution.

## + General use pads



## + Non-contact pads

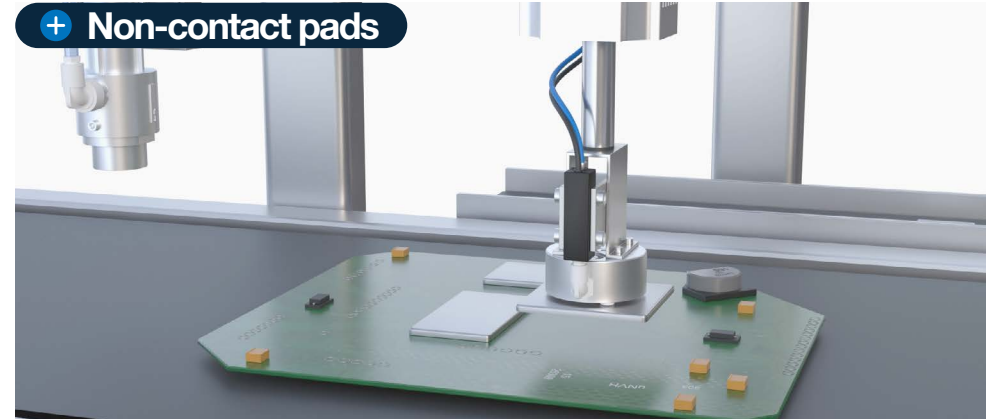

## + Food compatible pads



## + Vacuum pads with integrated ejector

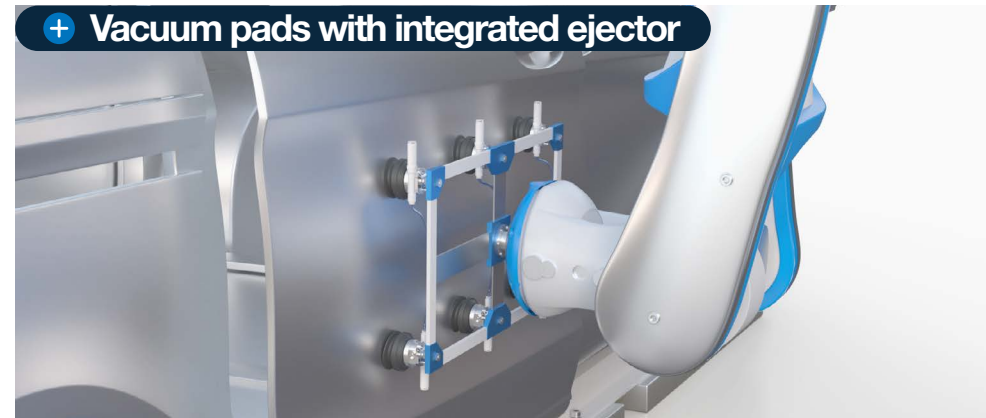



# Vacuum ejectors

Do you need to mount ejectors at the robots' moving parts? Do you need to generate vacuum while consuming less air at the same time? Do you need to monitor your ejectors remotely?

SMC's wide range of ejectors **meet all of your requirements** so you have the most **efficient solutions**.

## + Single ejectors



## + Ejector manifolds

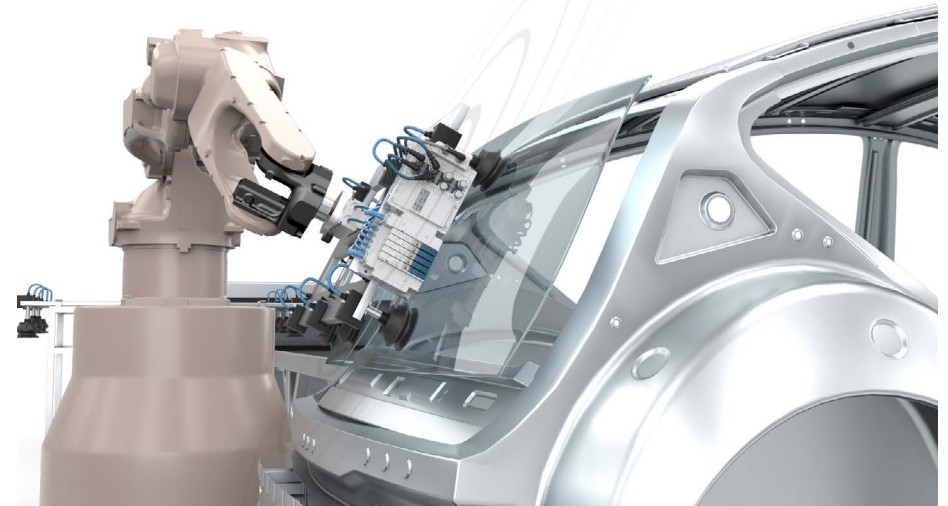

## + Positive-negative pressure combination manifolds

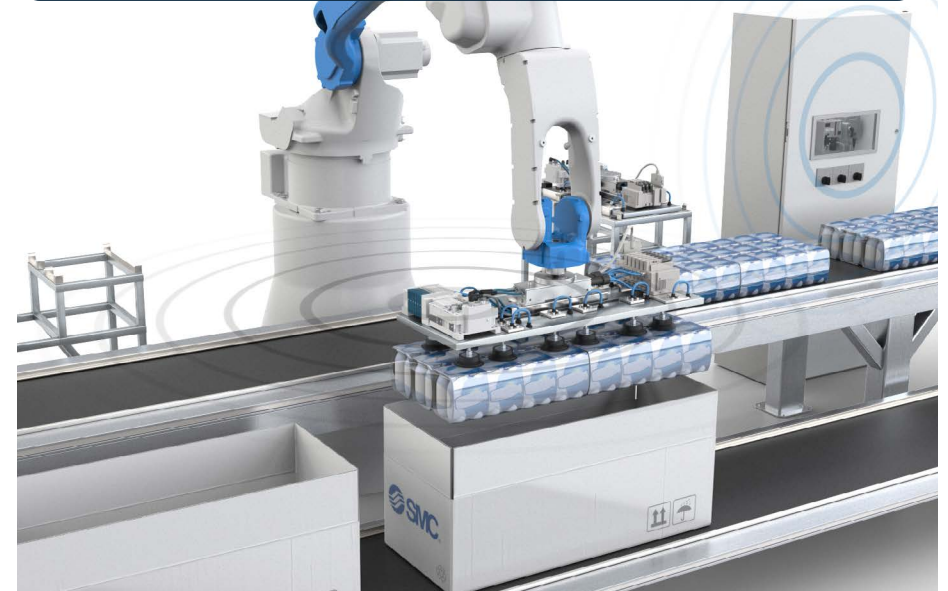



# Welding

## Reliable solutions for your welding robot

SMC provides **current-resistant** options for secure material fixing and precise positioning during welding. Our range also includes specialised tubing designed to endure the demanding conditions of the welding industry, offering excellent **resistance to spatter and harsh environments**.

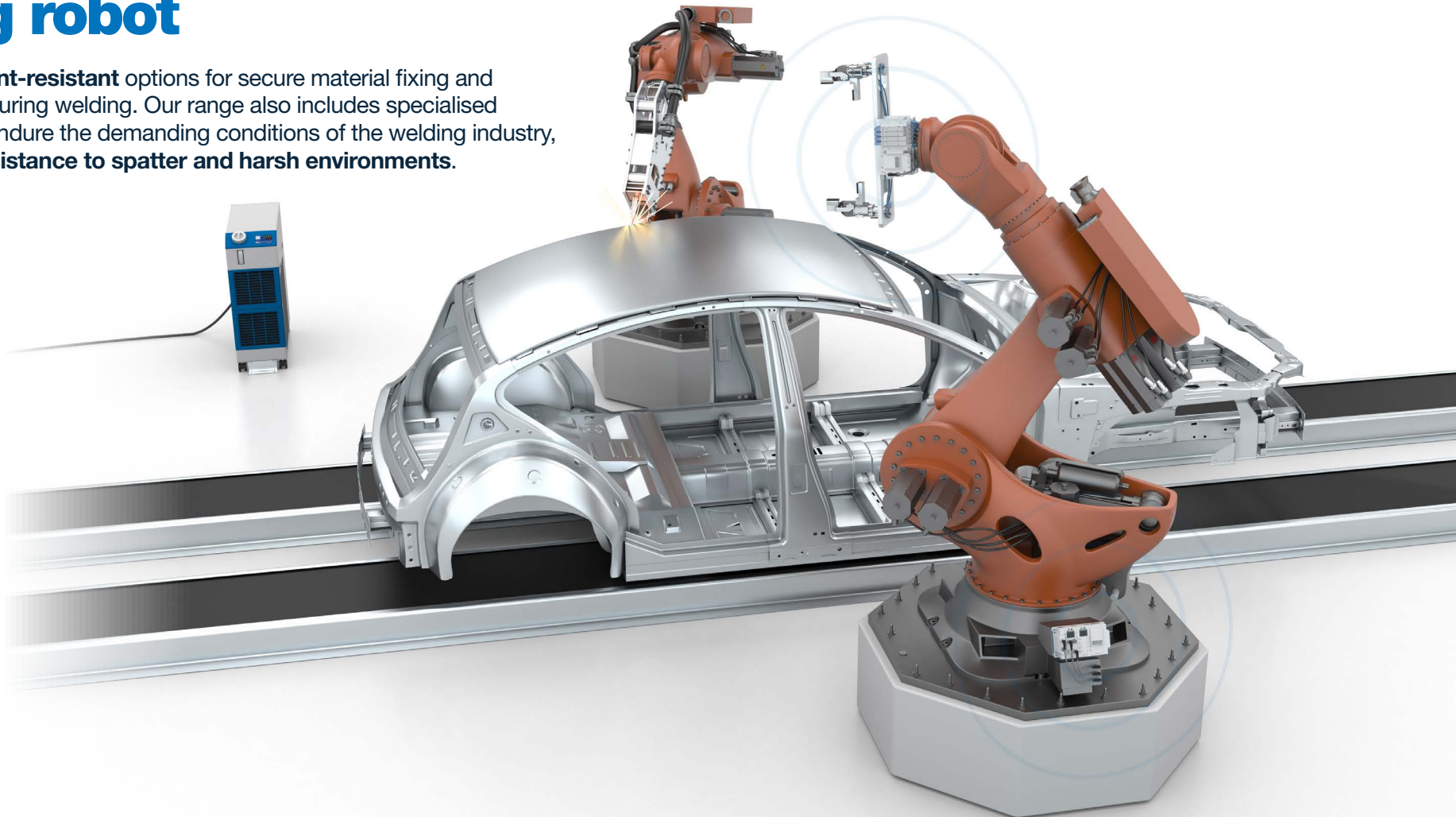

SMC understands the demanding nature of welding applications and offers solutions tailored to meet the market's needs. From current-resistant components for **precise material positioning to durable tubing that withstands spatter and harsh conditions**, our products are designed to ensure reliability and efficiency. With SMC, you can enhance the performance of your welding operations while maintaining the durability required in such challenging environments.



### Power clamp cylinder

#### + CKZT Series

- **Ensure your clamping operations in welding environments** – Spatter-proof construction. Rounded cover design and release button with minimal protrusion reduces weld spatter accumulation
- **Do you need to clamp small workpieces? Light and compact specific model** – As light as 580 g and as little as 34 mm wide and 192.4 mm high.



### Pin clamp cylinder

#### + CKQ Series

- **Positioning and clamping at the one time in environments exposed to magnetic fields**
- **Welding-friendly, but still light and compact for use in robot arms**
- **Guarantee safety** – Lock mechanism to prevent the dropping of workpieces during emergency stops.



### Flame-resistant tubing

#### + TRS/TRBU/TRTU Series

- **Suited for arc and spot welding** – Flame-resistant resin tubing (equivalent to UL-94 Standard V-0)
- **Wide variety of flame-resistant tubing:**
  - TRS Series: the simplest SMC flame-resistant tube
  - TRBU Series: double layer design with outer polyurethane flame-resistant tube
  - TRTU Series: the three-layer polyurethane tubing that improves spatter resistance by inserting an aluminium layer between the outer layer and the inner tube. TRTU performs best in the harshest environments.

# Painting

## Ensuring excellence in every coat

Achieve flawless results in your painting applications with SMC's range of **silicone-free products, specifically designed to meet the stringent demands of the automotive and paint industries.** Our solutions ensure optimal paint adhesion, eliminating the risks of contamination while making your process smoother and more efficient.

**Choose SMC** for reliable performance where quality is non-negotiable.

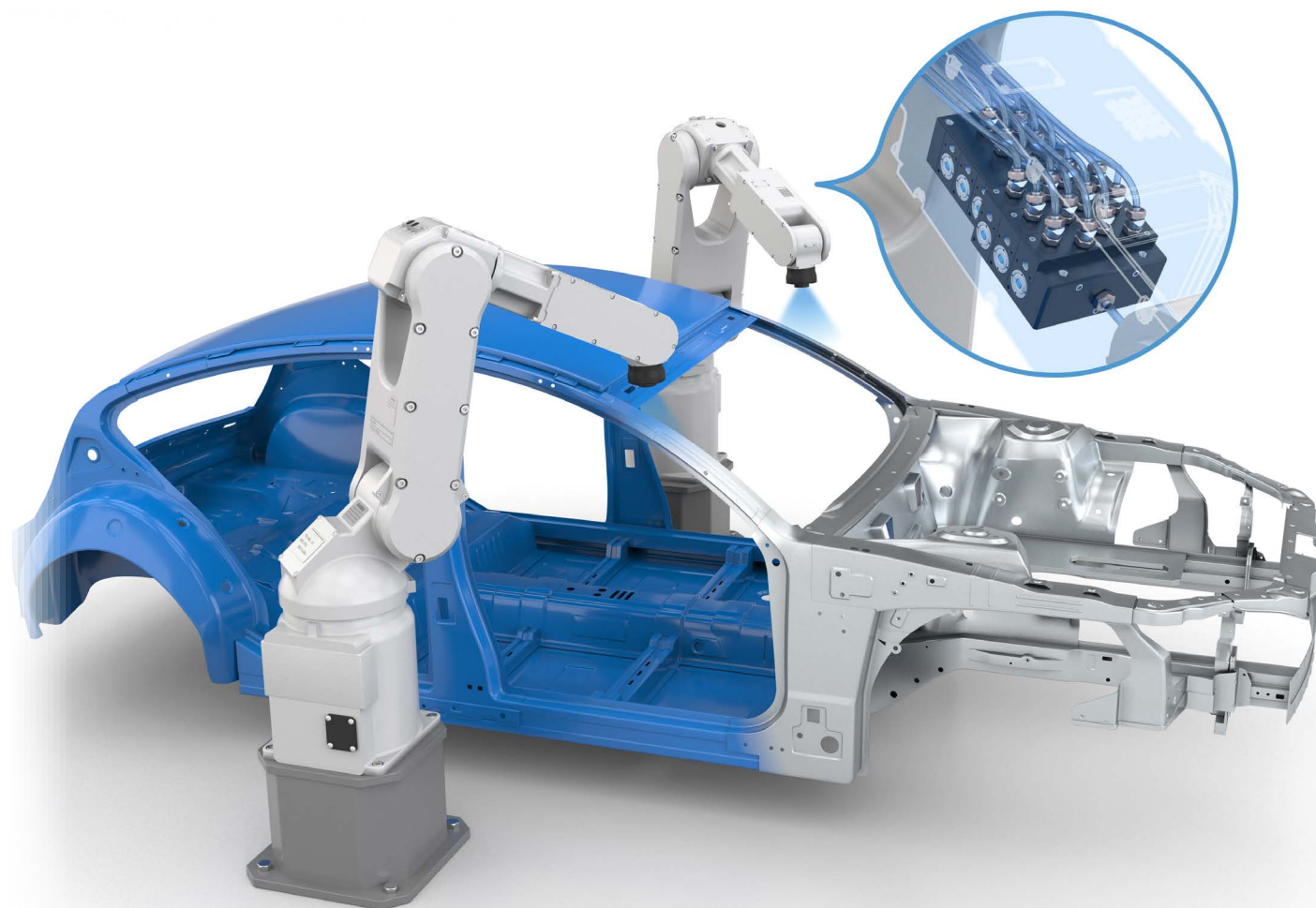

### Valve for water and chemical base fluids

#### + VCC Series

- **Perfectly designed for your robot arm** – Space-saving & light valves through a resin body with reduced paint deposit
- **Antistatic manifold applicable for water/chemical base paint and cleaning with solvent/air** – High reliability and long service life (2 million cycles).

We make your painting application easier with a variety of silicone-free products, a suitable choice for automotive and paint industries to **avoid detrimental effects on paint adhesion.**



### Fluoropolymer tubing

#### + TH Series

- **Perfect to use in extreme conditions** – Highly resistant to harsh fluids and solvents up to 200 °C, as well as the possibility of being used at high operating pressures.



### Stainless steel fitting

#### + VCK Series

- **Resists painting chemicals** – SUS316L stainless steel
- **Assures reduced residual liquids** – Resin surface sealing
- **Easy installation and removal in tight spaces, piping volume reduced** – 40° swivel elbow.



### High purity fluoropolymer fitting

#### + LQ Series

- **Avoids impurities within painting circuits for car bodies on painting lines in car industries** – New PFA material virtually eliminates particle generation and TOC (total organic carbon) allowing confident use in the most demanding applications
- **Resistant to harsh fluids and solvents up to 200 °C** – Strong resistance to tube bending and deformation.



# Life Science

## Innovating Life Science solutions – Big or small, we've got you covered

In the dynamic world of Life Sciences, precision, quality, and reliability are non-negotiable. SMC offers cutting-edge solutions tailored to meet your needs, whether you're a small organisation or a global enterprise. **From handling aggressive fluids to maintaining high purity with acrylic components, our products deliver exceptional performance and durability. Explore our range of fluid systems, quiet temperature control equipment, EOAT compliant with FDA, electric actuators and collaborative robot end effectors** – designed to support your innovations in life sciences.



**Precision and reliability for Life Sciences** – SMC delivers advanced solutions, from fluid systems to EOAT and electric actuators, ensuring high performance and compliance.



### 2/3 port solenoid valve for chemicals + LVM Series

- **Compact and lightweight** – Ideal for space-saving designs and easy integration into various systems
- **High-speed response** – Ensures quick and efficient operation, enhancing overall productivity
- **Versatile applications** – Suitable for a wide range of fluids, including chemicals and pure water
- **Durable construction** – Built with high-quality materials to withstand demanding environments and ensure long-lasting performance.

# Applications

## Glass handling

Adsorption marks must not be left on workpieces in glass handling applications. To this end, use our markfree vacuum pads – **ZP2 series**.

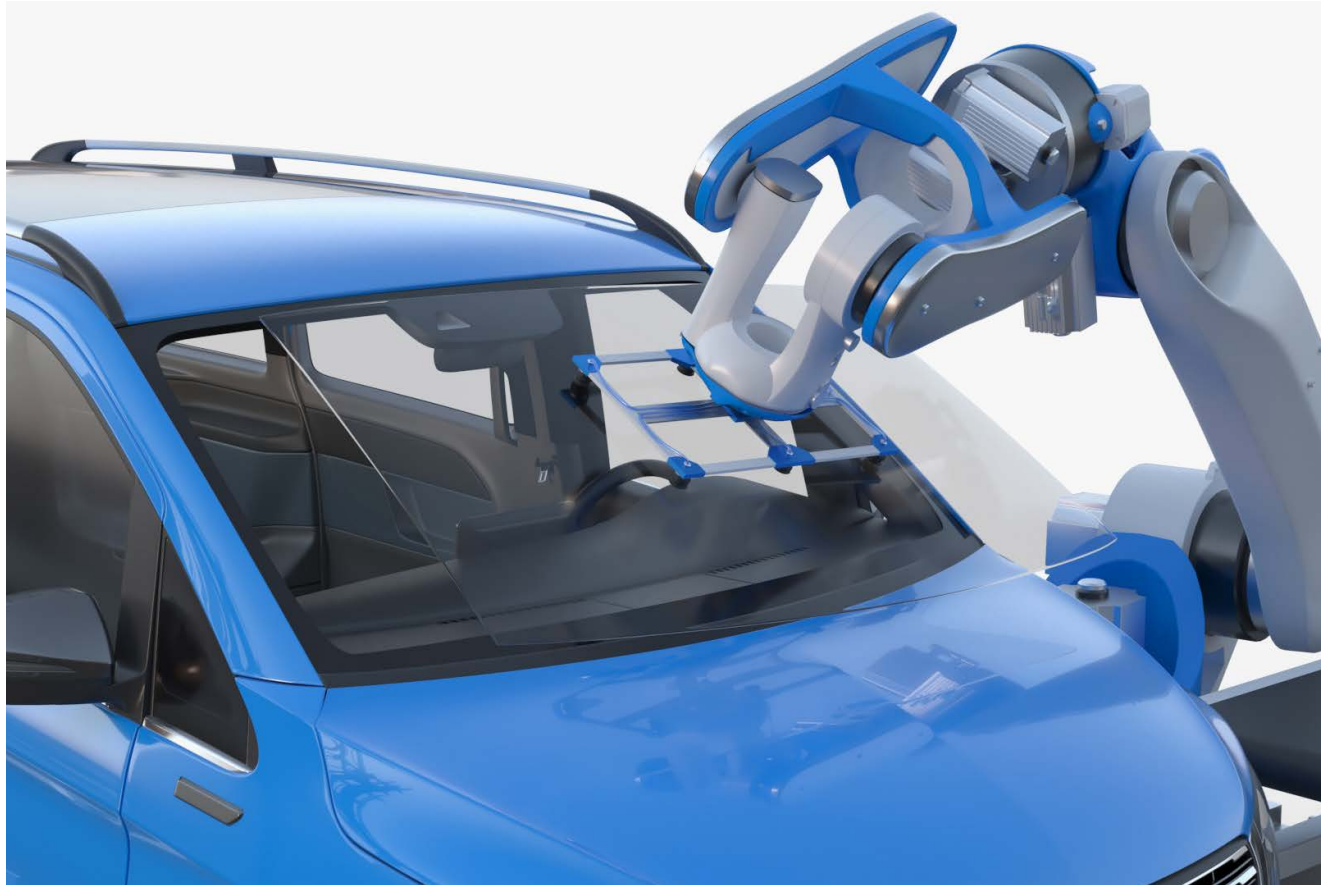

Vacuum pads cannot be used to support ferromagnetic workpiece with holes and uneven surfaces. Instead, use our magnetic gripper – **MHM Series**.

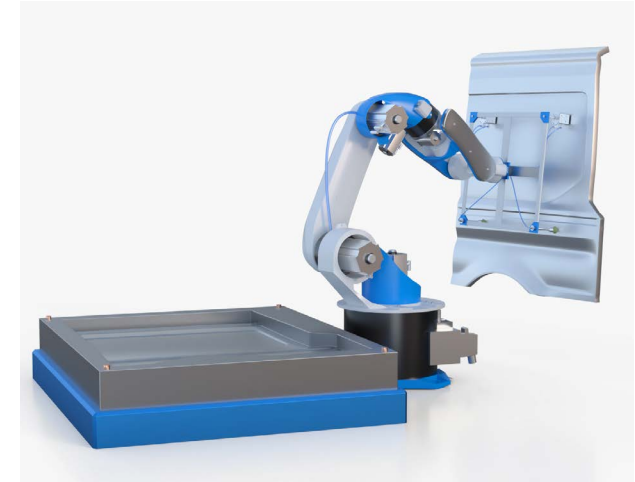

## Food packaging handling

Absorbing unstable, soft film-wrapped workpieces with high speed spider robots in the food industry require a highly adaptable pad skirt. To this end, use our FDA compliant blue vacuum pads – **ZP3P Series**.



## Direct food handling

Handling delicate, unpackaged food items with high-speed spider robots in the food industry requires a highly adaptable and hygienic solution. For this purpose, use our FDA compliant vacuum pads – **ZNC-C Series**.

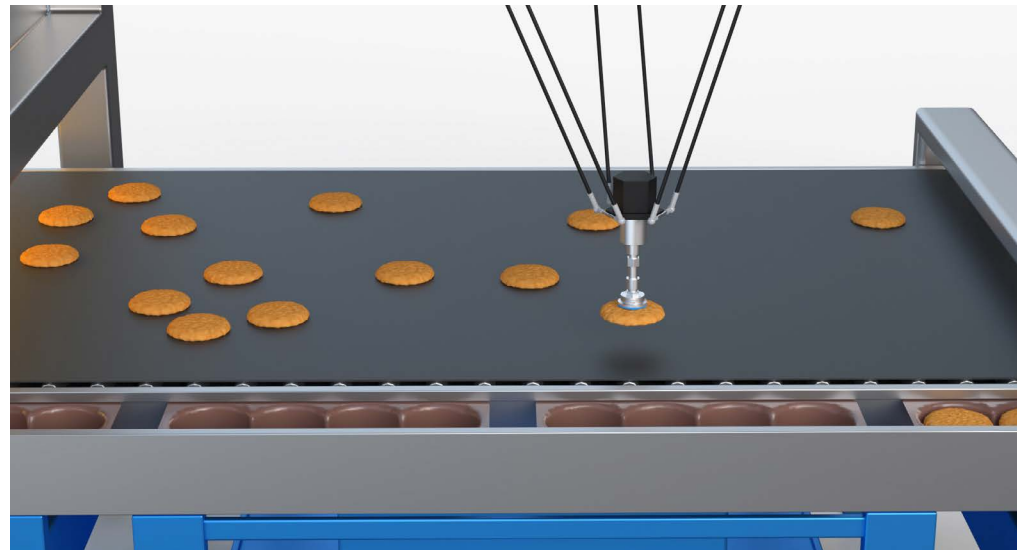



# Semi-conductor & electronics transfer

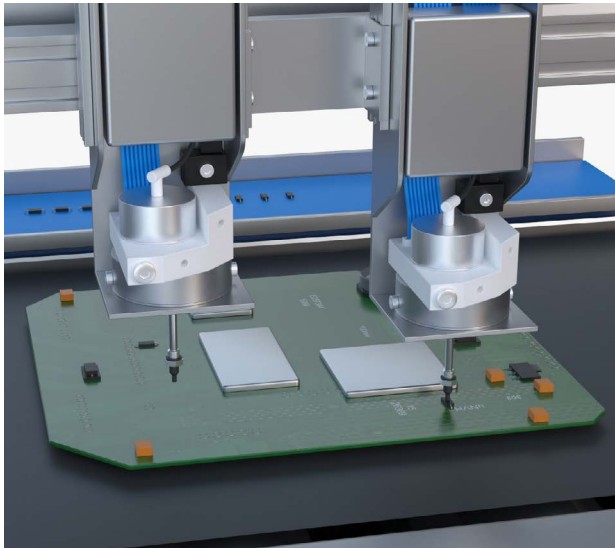

Scars or suction traces must not be left on workpieces in electronics or semi-conductor industries. To avoid problems, use our semiconductive vacuum pads – **ZP3 Series**.

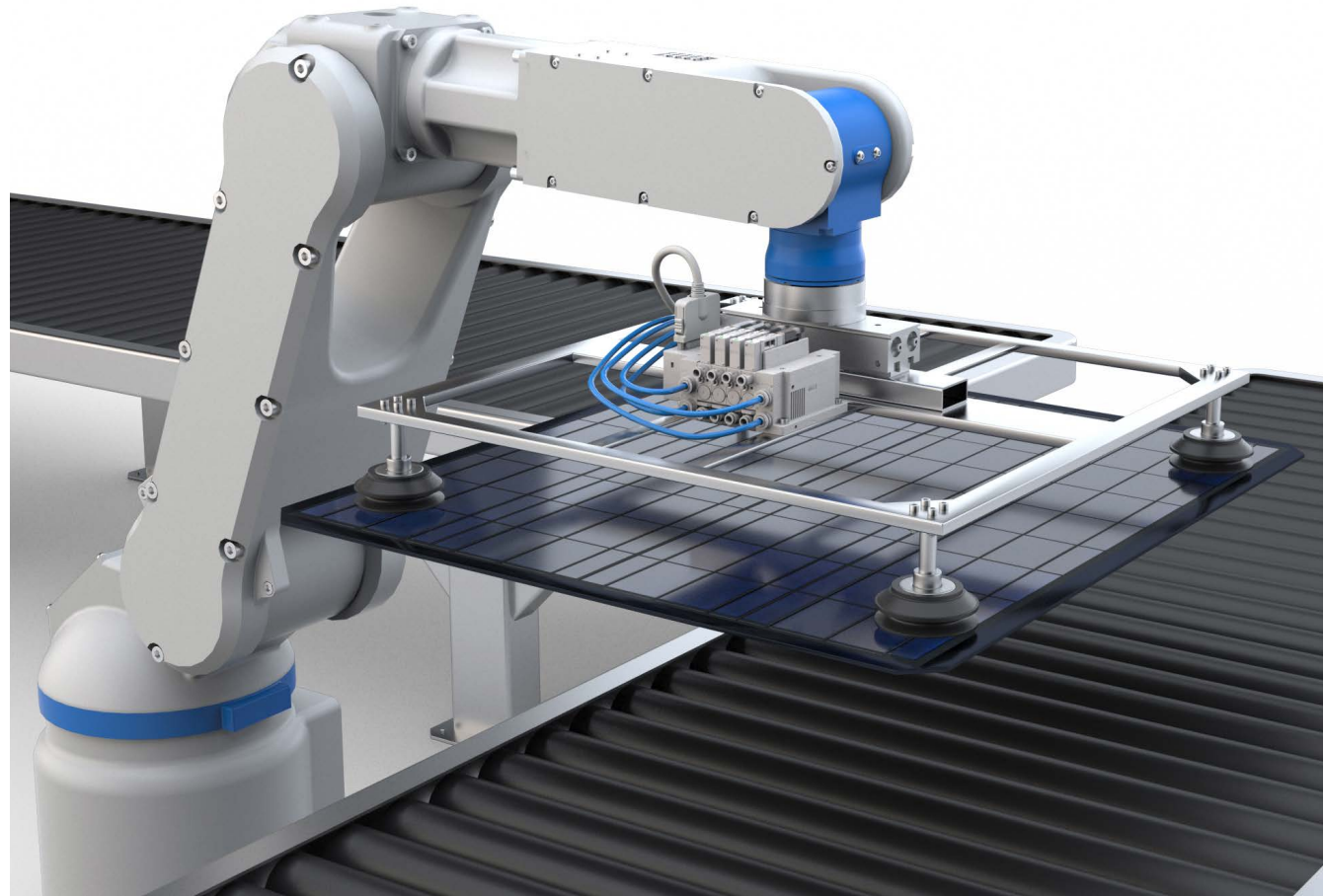

Electronic components usually need a precise and repetitive handling system. Check our miniature vacuum pads to handle these products – **ZP3 Series**.



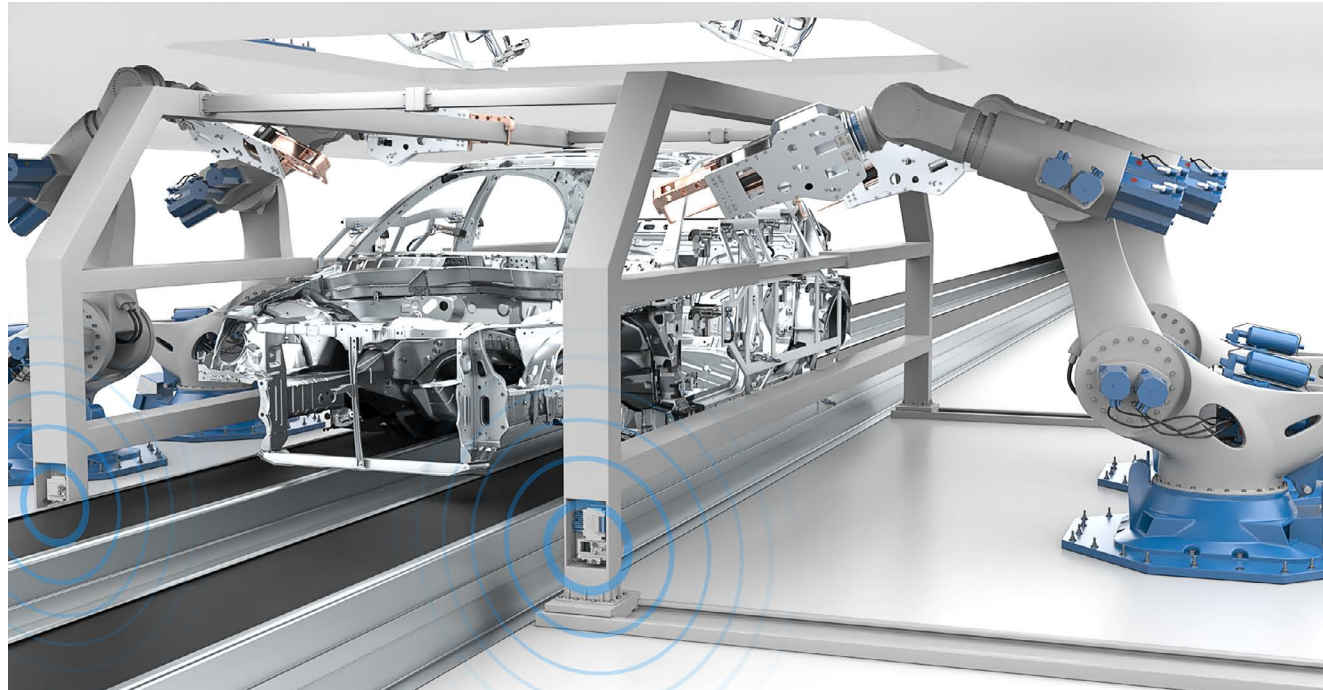

## Automotive assembly

In automotive assemblies, where welding points are applied while clamping certain workpieces, SMC offer temperature control – **HRSH Series**, heat resistant tubing – **TRTU Series**, power clamp cylinders – **CKZT Series** and compact solenoid valves to enhance the robot's productivity.

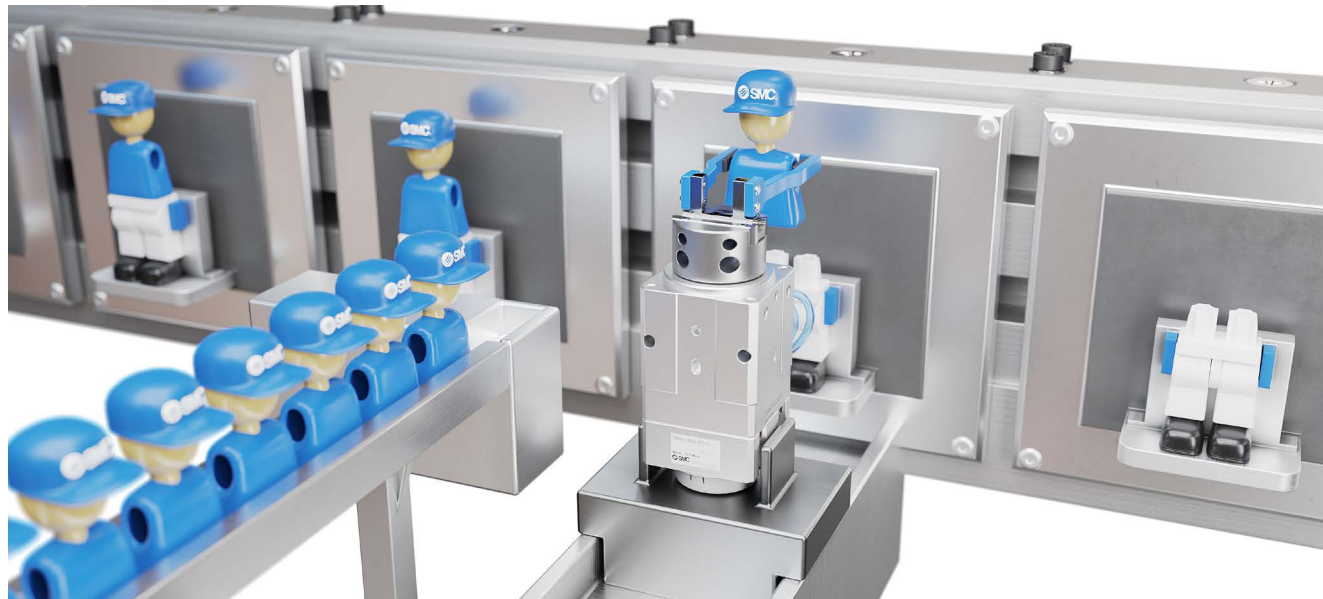

## Small assemblies

Handling delicate, small components y narrow spaces is perfectly possible with SMC's rotation grippers – **MQR Series**.

## AGVs

Propel cobots mounted on AGVs or ARVs with our compact compressor – **CRP Series** and let our vast gripper range do the rest.

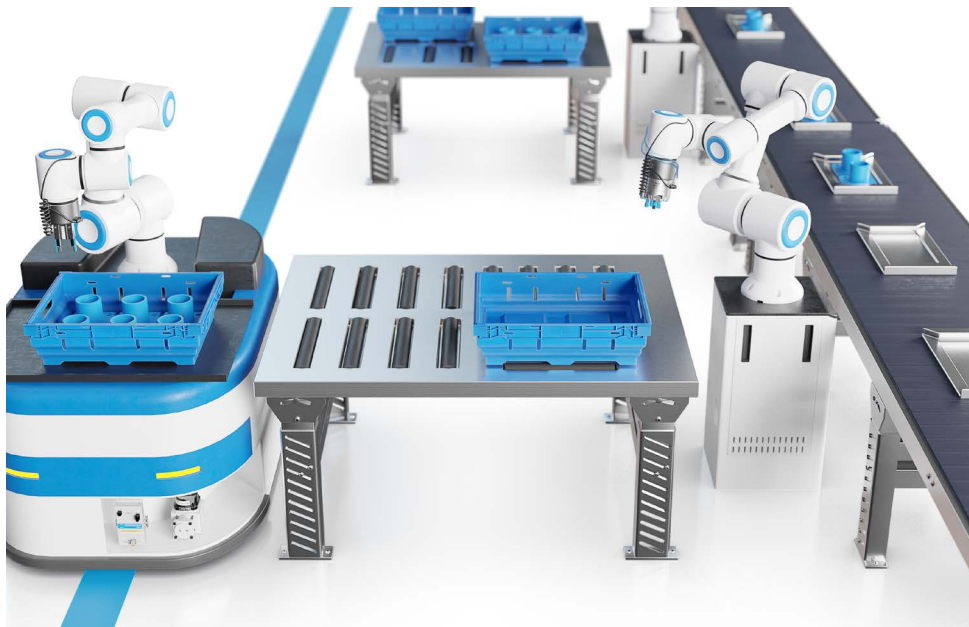

## Air-less production lines

Have problems to take air takes through your installation? Our compressor that will create positive and negative pressure will help you adapt your process. Combine the compact compressor – **CRP Series** together with SMC end effectors to solve all your needs.

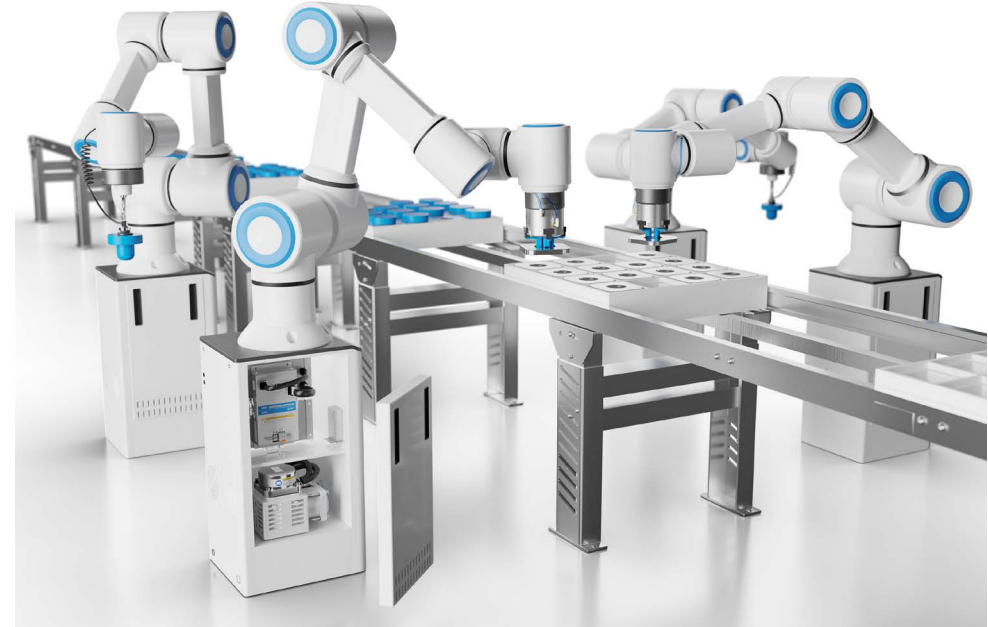

## Wireless processes

SMC's wireless solutions, including the **EXW1** and **EX600-W Series**, provide robust and reliable communication in factory automation environments. Utilizing the 2.4 GHz ISM frequency band with advanced frequency hopping technology, these systems minimize interference and ensure stable connections. Ideal for reducing wiring work and space, SMC's wireless solutions are perfect for high-speed, high-precision applications, including those in the food industry

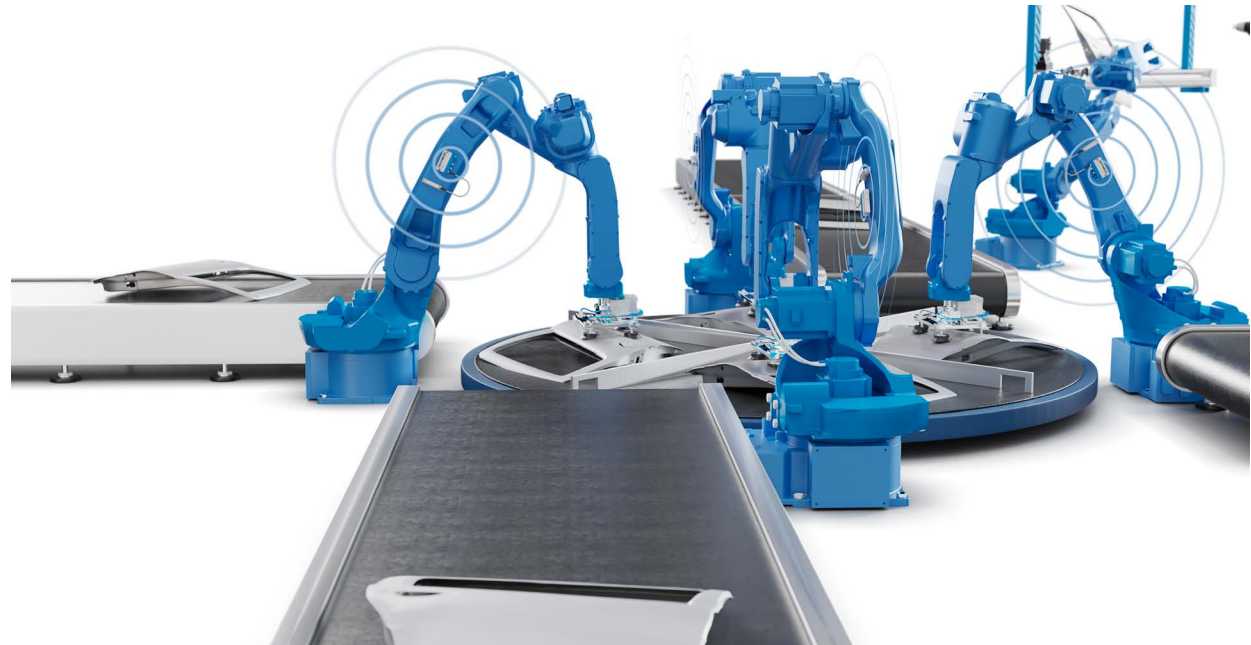

## Laser cutting

Achieving high-precision cuts in laser cutting applications requires reliable and accurate flow control. The SMC **PF3W Series** digital flow switch manifolds are designed to monitor and control water flow in laser cutting systems, in a centralised way. With a built-in temperature sensor and compatibility with various fluids, the PF3W series provides precise flow management, making it ideal for maintaining the efficiency and longevity of laser cutting equipment. Install up to 10 stations to enhance your control.

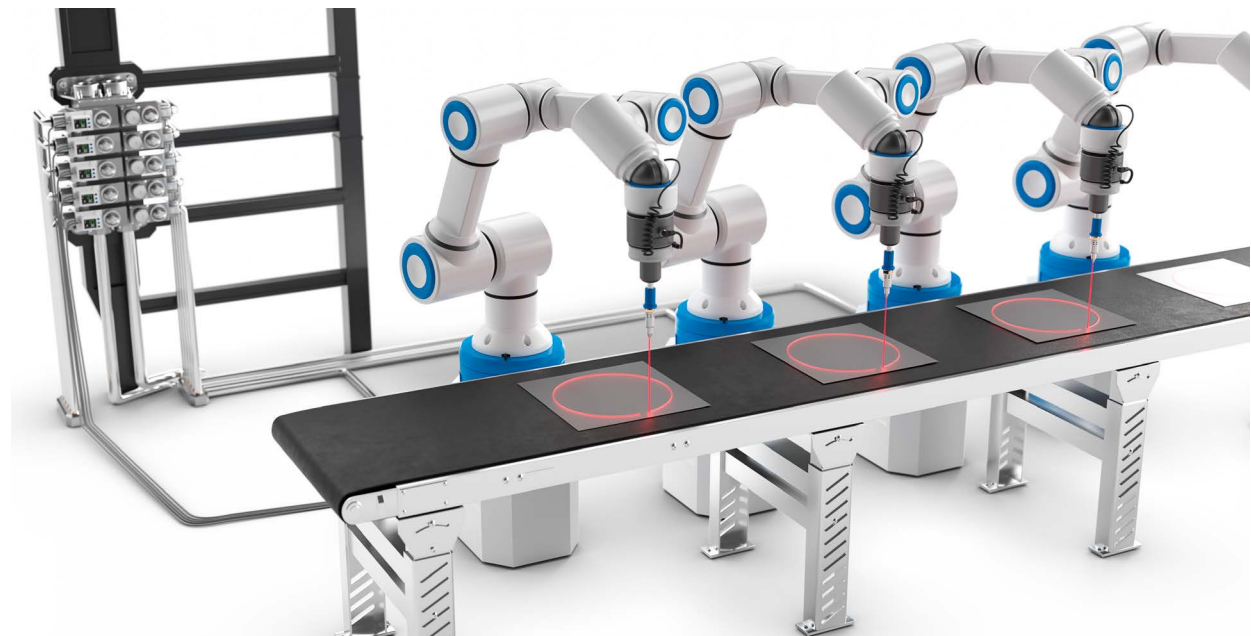



# Rotary tables

Achieving precise and efficient motion control in rotary table applications requires reliable and adaptable components. SMC offers a range of small actuators and grippers designed to meet these needs. The **MQR Series** low torque rotary joints ensure smooth and consistent rotation with minimal wear. Additionally, SMC's compact electric actuators, such as the **LEPY Series** mini electric cylinders, and small grippers, like the **MHS3 Series** 3-finger grippers, provide high-speed, accurate positioning and secure handling of delicate workpieces. These solutions are ideal for a variety of industrial applications, ensuring optimal performance and longevity.

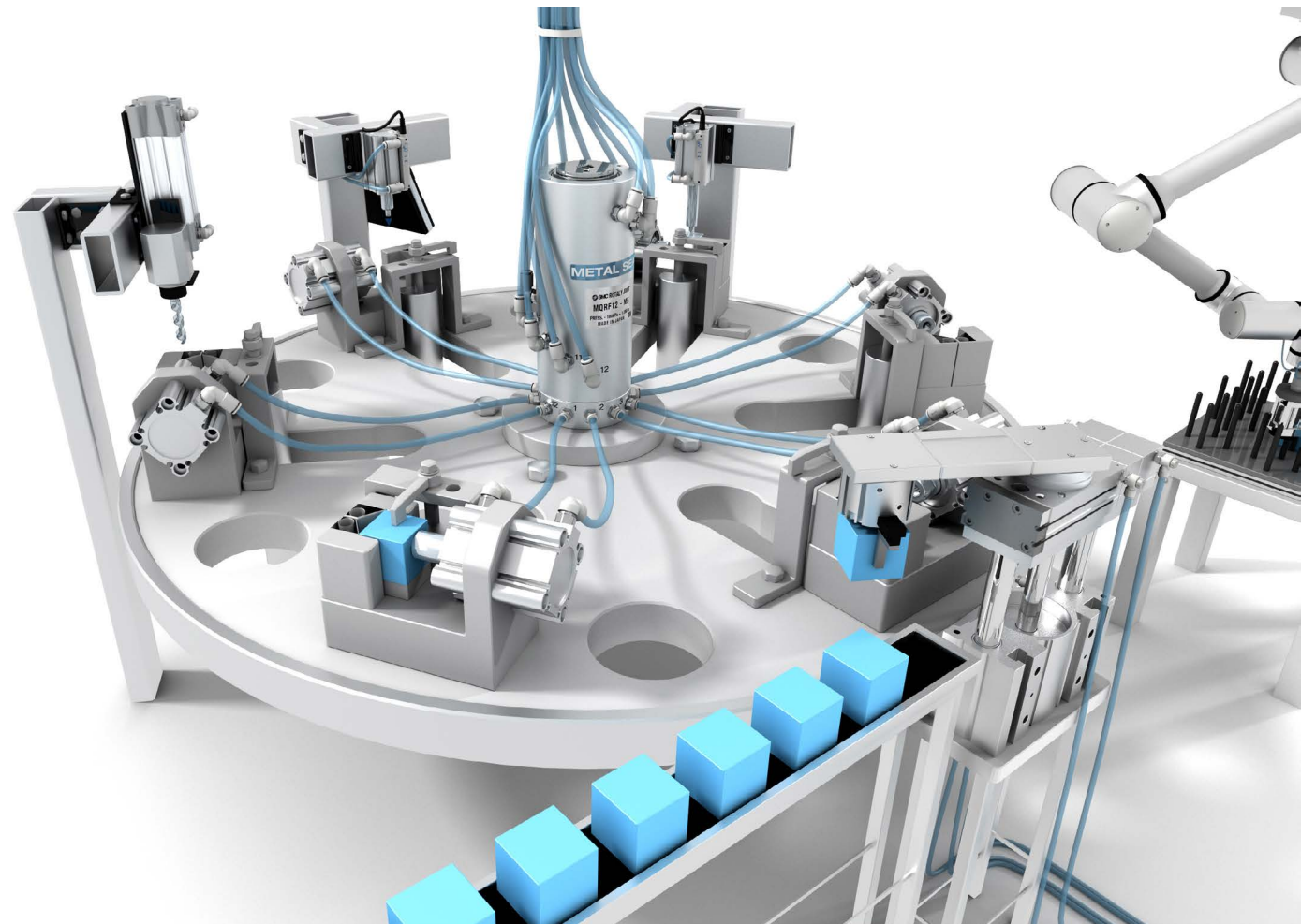
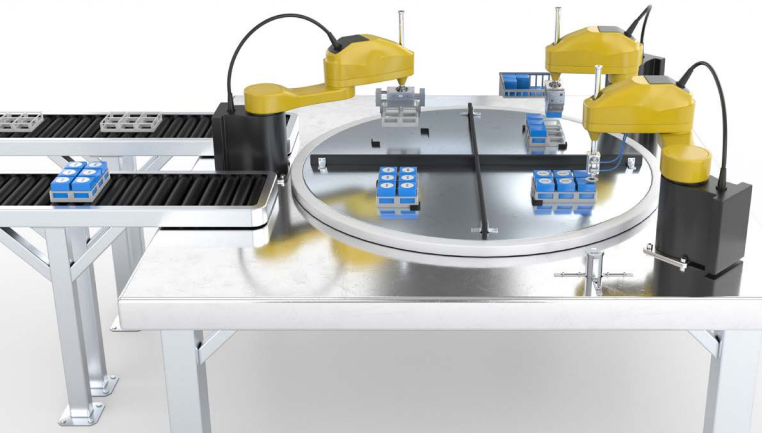



# One stop supplier

SMC provides a comprehensive range of products to create a **complete robotic solution**, offering everything from actuators and sensors to grippers and controllers. With advanced technologies and high-quality components, **SMC ensures precision, efficiency, and durability in robotic applications**. Our solutions are designed to meet the diverse needs of automation, providing flexibility in integration and optimal performance in even the most demanding environments. Whether you're looking for electric actuators, vacuum systems, or custom robotic accessories, **SMC offers the complete toolkit to drive your robotics projects forward**.

[See what solutions we offer to complement your robotic applications.](#)



## Thermo-chiller

### + HR Series

- **Compact and efficient** – Designed for space-saving and easy integration into various systems
- **Precise temperature control** – Ensures stable and accurate temperature regulation with a cooling capacity range from 0.2 kW to 38 kW
- **Versatile cooling options** – Suitable for both air-cooled and water-cooled systems, accommodating different cooling needs
- **Energy-saving features** – Equipped with advanced technology to reduce power consumption and enhance overall efficiency.

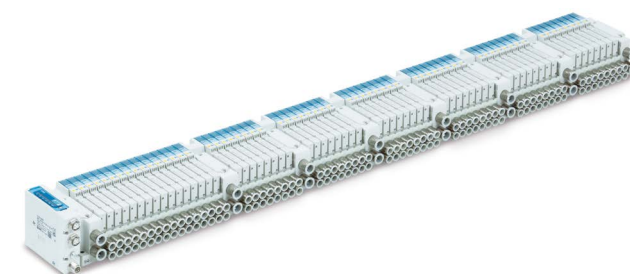

## 64-station compatible manifold plug-in compact 5-port

- + JSY3000-L Series
- + JSY3000-P Series

- **Reduced cabling and wiring** – Supports from 4 to 64 stations and 128 output points, minimising the number of SI units needed
- **Wide communication capabilities** – Compatible with PROFINET®, EtherNet/IP™, EtherCAT®, and IO-Link protocols
- **Space-saving design** – Installation space reduced by up to 110 mm, optimising your application layout
- **Robust and efficient** – Features serial wiring, plug-in connector base, a flow rate of up to 567 l/min, and IP67 enclosure for durability.



## Air Management System

### + AMS Series

- **Save energy and improve sustainability** – Programmable automatic pressure reduction and shut-off times
- **Enhanced maintenance capabilities** – Measurement and follow-up of flow, pressure, and temperature
- **Digitalise your compressed air installation** – Virtual control of parameters with fieldbus or OPC UA data collection
- **Reduce labour and wiring time** – Wireless connection up to 100-meter range and 10 remote units.



## Vacuum flow

### + ZHV Series

- **Maximise energy efficiency** – Multiplies air supply for blowing and suction by 4 and 3 times, respectively
- **High-flow performance** – Adjustable to blow up to 6820 l/min and vacuum up to 5270 l/min
- **Space-saving design** – Compact and lightweight, with reduced internal volume and as light as 46 grams
- **Simple operation and maintenance** – Air-driven, maintenance-free solution.



## Air flow controller

### + IN502 Series

- **Reliable flow rate adjustment** – Flow control independent of external factors
- **Compact and easy to install** – Combines flow sensor and regulator in a single unit, no control program needed
- **Wide application range** – Specific greases for industries such as food and automotive, with a maximum flow rate of 2000 l/min
- **User-friendly features** – 3-screen display, multiple output options (IO-Link, NPN/PNP, analogue), and IP65 enclosure for durability.

# Our support network

## SMC's worldwide commitment

One of the things we do best at SMC is **being close to our customers**. Local support, on a global scale.

With **support** in over **500 locations** across **80 countries** and regions **worldwide**, our sales force of **7000 experts** maintains **close communication with customers**.

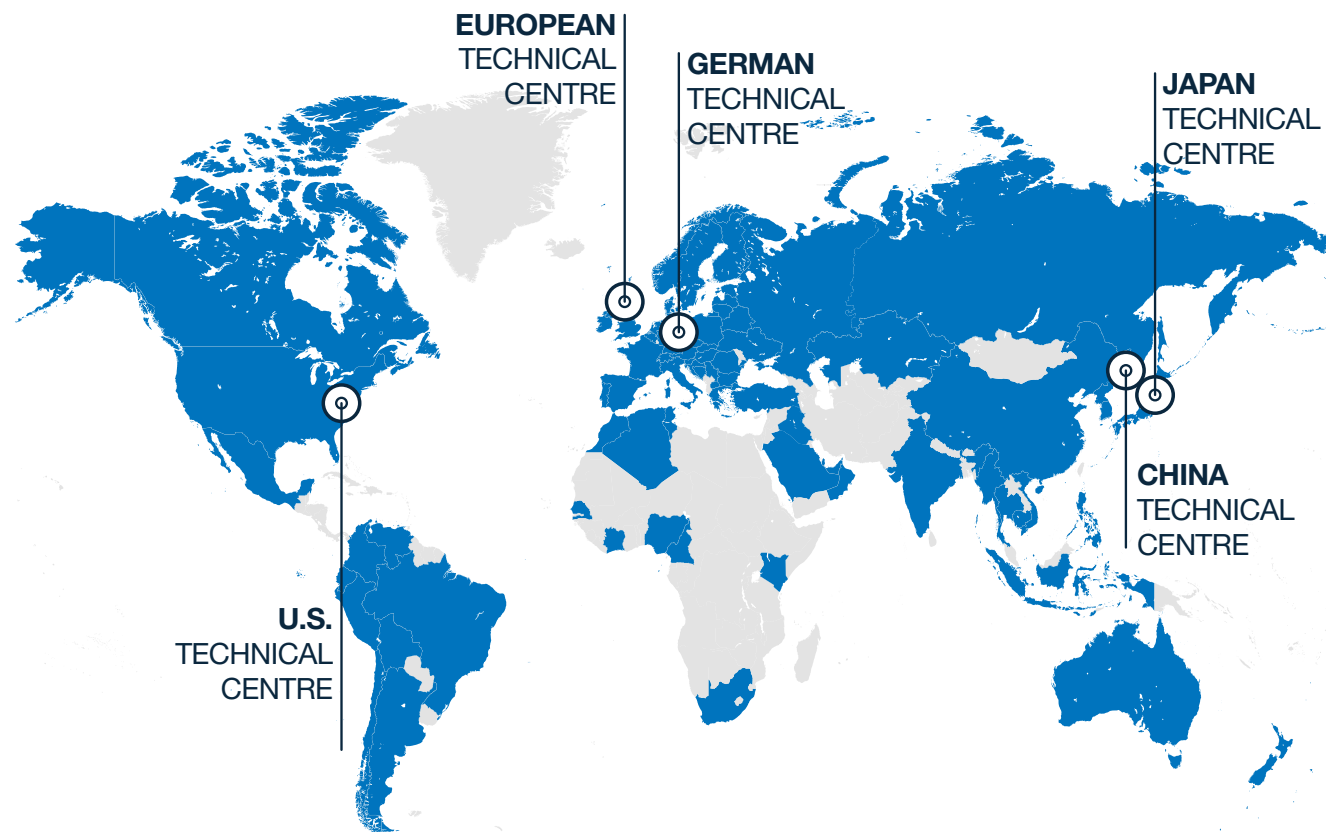

# SMC Business Continuity Plan

## Sustainable growth also means ensuring uninterrupted operations

We are committed to ensuring that SMC is prepared for any emergency and that our business activities will not stop in the event of such circumstances. SMC aims to fulfil our product supply responsibilities and maintain our customers' trust by contributing to both sustainable growth and the expansion of technological innovations.

SMC, as a comprehensive manufacturer of automatic control equipment that supports automation, is able to promptly provide products that meet our customers' needs anywhere in the world.

## Production BCP Ensure customer order fulfilment

Reliable delivery for you thanks to our 9 global logistic centres and 38 production sites worldwide, 10 of which are located in Europe. Moreover, flexibility to rapidly respond to any sudden change in the manufacturing environment.

## Finance BCP Safe & Solid financial base

In the event of an emergency, SMC can provide a safe and solid financial base (with cash, deposits, and equity capital) that will sufficiently cover the working capital and funds needed to rebuild buildings and the equipment required for business continuity. This is done to provide peace of mind to our customers and workers alike.

## Information security BCP Vital data kept safe

Strengthen information security for protection against computer viruses and cyberattacks, plus the installation of data centres to establish a disaster recovery system. Your information is safe with us.

## Engineering BCP Consistent technical support

2,100 engineers at our 5 technical centres around the globe (2 in Europe – Germany and UK).

## Sales BCP Consistent sales support

7,000 sales engineers worldwide ready to recommend the best solution for you. Over 80 global locations to make sure that wherever you are, we are there too.

[+](#) Discover more





## SMC Corporation

1-5-5, Kyobashi,  
Chuo-ku, Tokyo  
104-0031, Japan  
Telephone: 03-6628-3000  
<https://www.smcworld.com>

<b>Austria</b>	+43 (0)2262622800	<a href="http://www.smc.at">www.smc.at</a>	<a href="mailto:office.at@smc.com">office.at@smc.com</a>						
<b>Belgium</b>	+32 (0)33551464	<a href="http://www.smc.be">www.smc.be</a>	<a href="mailto:info@smc.be">info@smc.be</a>						
<b>Bulgaria</b>	+359 (0)2807670	<a href="http://www.smc.bg">www.smc.bg</a>	<a href="mailto:sales.bg@smc.com">sales.bg@smc.com</a>						
<b>Croatia</b>	+385 (0)13707288	<a href="http://www.smc.hr">www.smc.hr</a>	<a href="mailto:sales.hr@smc.com">sales.hr@smc.com</a>						
<b>Czech Republic</b>	+420 541424611	<a href="http://www.smc.cz">www.smc.cz</a>	<a href="mailto:office.at@smc.com">office.at@smc.com</a>						
<b>Denmark</b>	+45 70252900	<a href="http://www.smc.dk.com">www.smc.dk.com</a>	<a href="mailto:smc.dk@smc.com">smc.dk@smc.com</a>						
<b>Estonia</b>	+372 651 0370	<a href="http://www.smcee.ee">www.smcee.ee</a>	<a href="mailto:info.ee@smc.com">info.ee@smc.com</a>						
<b>Finland</b>	+358 207513513	<a href="http://www.smc.fi">www.smc.fi</a>	<a href="mailto:smc.fi@smc.com">smc.fi@smc.com</a>						
<b>France</b>	+33 (0)164761000	<a href="http://www.smc-france.fr">www.smc-france.fr</a>	<a href="mailto:supportclient.fr@smc.com">supportclient.fr@smc.com</a>						
<b>Germany</b>	+49 (0)61034020	<a href="http://www.smc.de">www.smc.de</a>	<a href="mailto:info.de@smc.com">info.de@smc.com</a>						
<b>Greece</b>	+30 210 2717265	<a href="http://www.smcHELLAS.gr">www.smcHELLAS.gr</a>	<a href="mailto:sales@smcHELLAS.gr">sales@smcHELLAS.gr</a>						
<b>Hungary</b>	+36 23513000	<a href="http://www.smc.hu">www.smc.hu</a>	<a href="mailto:office.hu@smc.com">office.hu@smc.com</a>						
<b>Ireland</b>	+353 (0)14039000	<a href="http://www.smcAutomation.ie">www.smcAutomation.ie</a>	<a href="mailto:technical.ie@smc.com">technical.ie@smc.com</a>						
<b>Italy</b>	+39 03990691	<a href="http://www.smcitalia.it">www.smcitalia.it</a>	<a href="mailto:mailbox.it@smc.com">mailbox.it@smc.com</a>						
<b>Latvia</b>	+371 67817700	<a href="http://www.smc.lv">www.smc.lv</a>	<a href="mailto:info.lv@smc.com">info.lv@smc.com</a>						
<b>Lithuania</b>	+370 5 2308118	<a href="http://www.smc.lt">www.smc.lt</a>	<a href="mailto:info.lt@smc.com">info.lt@smc.com</a>						
<b>Netherlands</b>	+31 (0)205318888	<a href="http://www.smc.nl">www.smc.nl</a>	<a href="mailto:info@smc.nl">info@smc.nl</a>						
<b>Norway</b>	+47 67129020	<a href="http://www.smc-norge.no">www.smc-norge.no</a>	<a href="mailto:post.no@smc.com">post.no@smc.com</a>						
<b>Poland</b>	+48 22 344 40 00	<a href="http://www.smc.pl">www.smc.pl</a>	<a href="mailto:office.pl@smc.com">office.pl@smc.com</a>						
<b>Portugal</b>	+351 214724500	<a href="http://www.smc.eu">www.smc.eu</a>	<a href="mailto:apoiocliente.pt@smc.com">apoiocliente.pt@smc.com</a>						
<b>Romania</b>	+40 213205111	<a href="http://www.smcromania.ro">www.smcromania.ro</a>	<a href="mailto:office.ro@smc.com">office.ro@smc.com</a>						
<b>Russia</b>	+7 (812)3036600	<a href="http://www.smc.eu">www.smc.eu</a>	<a href="mailto:sales@smcru.com">sales@smcru.com</a>						
<b>Slovakia</b>	+421 (0)413213212	<a href="http://www.smc.sk">www.smc.sk</a>	<a href="mailto:sales.sk@smc.com">sales.sk@smc.com</a>						
<b>Slovenia</b>	+386 (0)73885412	<a href="http://www.smc.si">www.smc.si</a>	<a href="mailto:office.si@smc.com">office.si@smc.com</a>						
<b>Spain</b>	+34 945184100	<a href="http://www.smc.eu">www.smc.eu</a>	<a href="mailto:post.es@smc.com">post.es@smc.com</a>						
<b>Sweden</b>	+46 (0)86031240	<a href="http://www.smc.nu">www.smc.nu</a>	<a href="mailto:order.se@smc.com">order.se@smc.com</a>						
<b>Switzerland</b>	+41 (0)523963131	<a href="http://www.smc.ch">www.smc.ch</a>	<a href="mailto:helpcenter.ch@smc.com">helpcenter.ch@smc.com</a>						
<b>Turkey</b>	+90 212 489 0 440	<a href="http://www.smcTurkey.com.tr">www.smcTurkey.com.tr</a>	<a href="mailto:satis.tr@smc.com">satis.tr@smc.com</a>						
<b>UK</b>	+44 (0)845 121 5122	<a href="http://www.smc.uk">www.smc.uk</a>	<a href="mailto:sales.gb@smc.com">sales.gb@smc.com</a>						
<b>South Africa</b>	+27 10 900 1233	<a href="http://www.smcza.co.za">www.smcza.co.za</a>	<a href="mailto:Sales.za@smc.com">Sales.za@smc.com</a>						

## www.smc.eu

Release DV  
ROB01-B-UK

SPECIFICATIONS ARE SUBJECT TO CHANGE WITHOUT PRIOR NOTICE AND ANY OBLIGATION ON THE PART OF THE MANUFACTURER