



SMC'S SOLUTIONS FOR INTRALOGISTICS

**Automate
flow.
Deliver
results.**

Expertise
Passion
Automation



The role of industrial automation in intralogistics



Intralogistics has become a strategic pillar for modern warehouses and distribution centres. As companies adopt Industry 4.0, automation enables **faster operations, higher accuracy and real-time visibility of material flows**. Automated transport systems, robotic handling and intelligent storage solutions are transforming how goods move inside facilities, reducing manual labour, improving safety and accelerating order fulfilment.

At SMC, we support this transition with a comprehensive portfolio **designed for flexible, safe, data-driven and energy-efficient intralogistics environments**. From compact pneumatic components to advanced electric actuators, wireless communication systems and vacuum technologies, we provide the reliability and performance required to optimise key intralogistics processes.

Autonomous mobile robots & AGVs

Collaborative robots in warehouses have to balance speed with safety, working alongside humans in confined areas. **Lightweight and flexible equipment is required** to maintain safe interaction while providing enough strength and precision for picking, placing or packaging tasks. Frequent product changes require cobots to deliver consistent performance despite limited payloads and continuous cycles.

SMC supports autonomous transport platforms with **compact and lightweight products, vacuum components and wireless communication systems** that reduce cabling and simplify integration. Our components ensure reliable gripping, lifting and load transfer in mobile systems that must remain agile and energy-efficient.



ZXPE5 Series +

Electric vacuum gripper for collaborative robots



EXW1 Series +

Compact wireless base unit



CRP Series +

Compact compressor

Flexibility for end-of-arm tooling

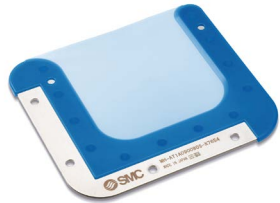

MH-X7654 Series +

Elastic finger for grippers



MHS3 Series +

3 finger gripper, wedge cam style, standard



RMMA Series +

Multi hand adapter



LEHR Series +

Electric gripper for collaborative robots

Growing product diversification and **frequent changes in shape** are placing increasing pressure on automated handling processes. End-of-arm tooling has to be able to manage different forms, materials and surface conditions without compromising product integrity or production continuity. Inadequate tooling flexibility can lead to product damage, extended changeover times and reduced throughput.

SMC addresses these challenges **with versatile end-of-arm tooling solutions** designed to adapt to a wide range of product types and handling requirements.

By combining flexible gripping technologies with a range of tool changers and multi-hand adaptors, SMC EOAT solutions enable safe and damage-free handling while maintaining fast and consistent cycle times. This versatility allows manufacturers to respond quickly to changing production needs, improve overall efficiency and future-proof their automation systems.

+ [Discover our solutions for robotics](#)



Robotic picking and handling

Automated picking and handling systems are up against demanding conditions due to the **infinite variation of products** found in modern warehouses. Systems must adapt to constant SKU changes while maintaining speed, precision and gentle handling to avoid damaging goods.

Space constraints, lighter equipment needs and continuous operation add further complexity, as robots must deliver **short cycle times** with high reliability. At the same time, **seamless communication and real-time feedback** are essential for integration into flexible, data-driven intralogistics workflows.

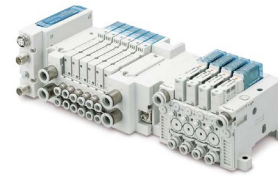
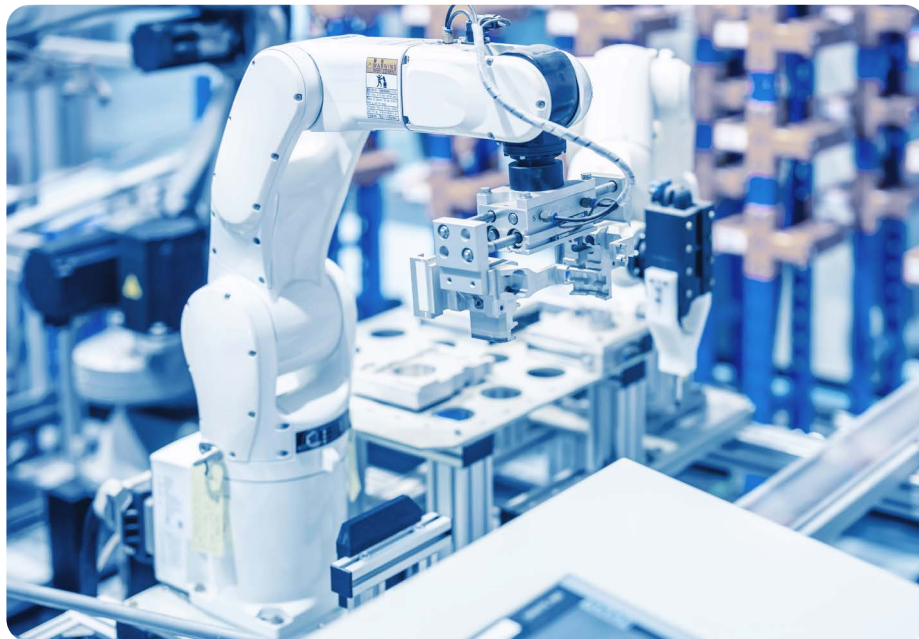

JSY & ZK2□A Series +

Valve and ejector combination manifold



ZP3C Series +

Abrasion resistant vacuum pad



ZGS Series +

Vacuum gripper system

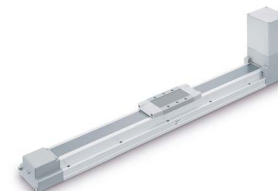

LEFB, LEFG-BS Series +

Electric actuator, slider type, belt drive

Digitalisation for the warehouse of the future

Rapidly evolving market demands continue to challenge the industry to constantly update technologies and systems. Warehouses that are not digitalised fail to unlock the full potential of **data collection and data-driven decision-making**. Our range allows for support of not just our own solutions but also offers integration with existing standalone systems you may already have.

SMC actively develops and delivers innovative solutions that enable factory floors to achieve the expected levels of efficiency, while supporting system **flexibility and scalability**. This approach allows for easy layout modifications, seamless integration and full access to valuable operational data.

[+ Discover more about SMC's digital architecture](#)



EXW1-RDC Series [+](#)

Compact wireless remote, digital input/output



AMS-X-X2044/X2045 Series [+](#)

Air Management System, IO-Link compatible

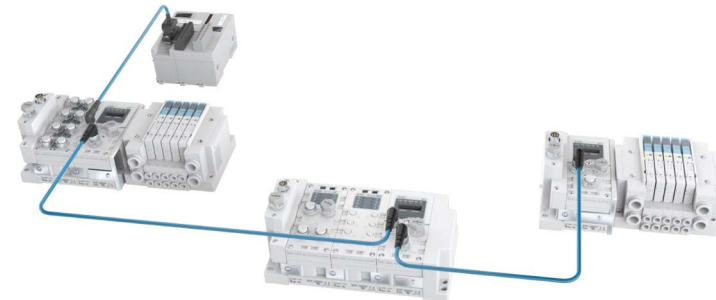

EX600 Series [+](#)

Decentralised valve manifold system with fieldbus unit

Smart sorting, labelling & packing

Sorting and packing lines often operate at high speeds, **requiring components that can react instantly to size, weight and destination changes**. Systems must manage frequent start-stop cycles, eject items with precision and handle packaging materials that may be delicate or irregular. Consistent performance under continuous load, along with accurate sensing and controlled motion, is essential to avoid mis-sorts, product damage or bottlenecks in order processing.



SMC solutions such as high-response valves, ejectors, pressure sensors and electropneumatic regulators **ensure precise airflow control in high-speed sorting lines**. For labelling and packing, our compact actuators and vacuum technologies enable gentle but secure handling to avoid product damage.

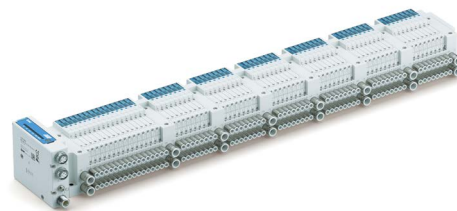

JSY1000/3000-L Series +

64-station compatible manifold plug-in compact 5-port solenoid valve



IZT43 Series +

Nozzle type ionizer, separate controller



CQ2-XB24 Series +

Longer life compact cylinder



IITV23 Series +

Electro-pneumatic regulator, manifold type

Energy efficiency solutions

Over the years, at SMC we have been fully committed to different energy-saving activities addressed at assisting our customers in reducing their bills and, why not? This is our modest contribution to global sustainability. We have accomplished different levels of energy-saving actions in our customers' factories, conducting energy audits, working towards green procurement, etc.

Let's go towards energy efficiency together, we have worldwide teams of specialists ready to support you.



Discover more about our Energy-efficient solutions



Generate just what you need

Analysing our energy bills with a critical view. Is our total consumption justified?



Recover what you generate

Different technologies to reuse energy (heat, released air, etc.)



Monitor your consumption

Only when we know what's going on, can we enact effective energy-management policies.

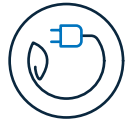

Use only the essential

How can we use energy more rationally in production processes? Plus, the necessary re-think on the way things have been done in the past.



Think efficient

The concept that closes the loop and the most important one. Impregnate your day-to-day with energy efficiency.



AMS20/30/40/60 Series +

Air Management System

Conveyor & Transfer systems

Conveyor systems must ensure **smooth and synchronised movement across long distances** while handling variable loads and product dimensions. They must remain reliable despite round-the-clock operation and exposure to dust, vibration or frequent speed changes. **Compact, durable components and precise control** are needed to maintain consistent transfer between zones and prevent jams or uneven product spacing.

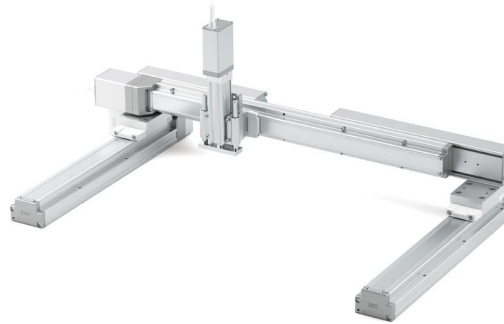

LEA Series +

Electric actuator, multi-axis system, gantries (X, Y, Z axes with support guides)



EQFS□H Series +

Integrated controller slider type electric actuator



EQYG□H Series +

Integrated controller guide rod type



EQY□H Series +

Integrated controller rod type electric actuator



MACM Series +
Centring unit



RS2H Series +
Heavy duty stopper cylinder



LEB Series +
Electric stopper actuator



DAS Series +
Deceleration controller

Functional safety in material transfer systems

Human-machine interaction is an inherent part of material transfer processes, where goods move across multiple platforms, conveyors and sorting systems. Ensuring safe operation throughout these interactions is critical to maintaining both system reliability and operational continuity.

With a strong focus on **reducing any risk**, SMC is committed to the development of ISO 13849-compliant safety components that support **the safe design and operation of automated transfer systems**. These solutions help manufacturers protect personnel, safeguard equipment and maintain consistent performance across complex material handling environments.



[+ Discover more about machinery safety](#)



VPX400 Series [+](#)

Safety exhaust valve, modular connection type



C96N-X3075 Series

Cylinder with lock unit

For more information please contact SMC.



EX260 Series [+](#)

Compact fieldbus system for output with PROFIsafe and safety over EtherCAT®



LECSB-T Series [+](#)

AC servo motor driver with STO pulse input type

Facts over words

See how SMC has helped customers to achieve successful implementation of automation solutions in their material handling flows.

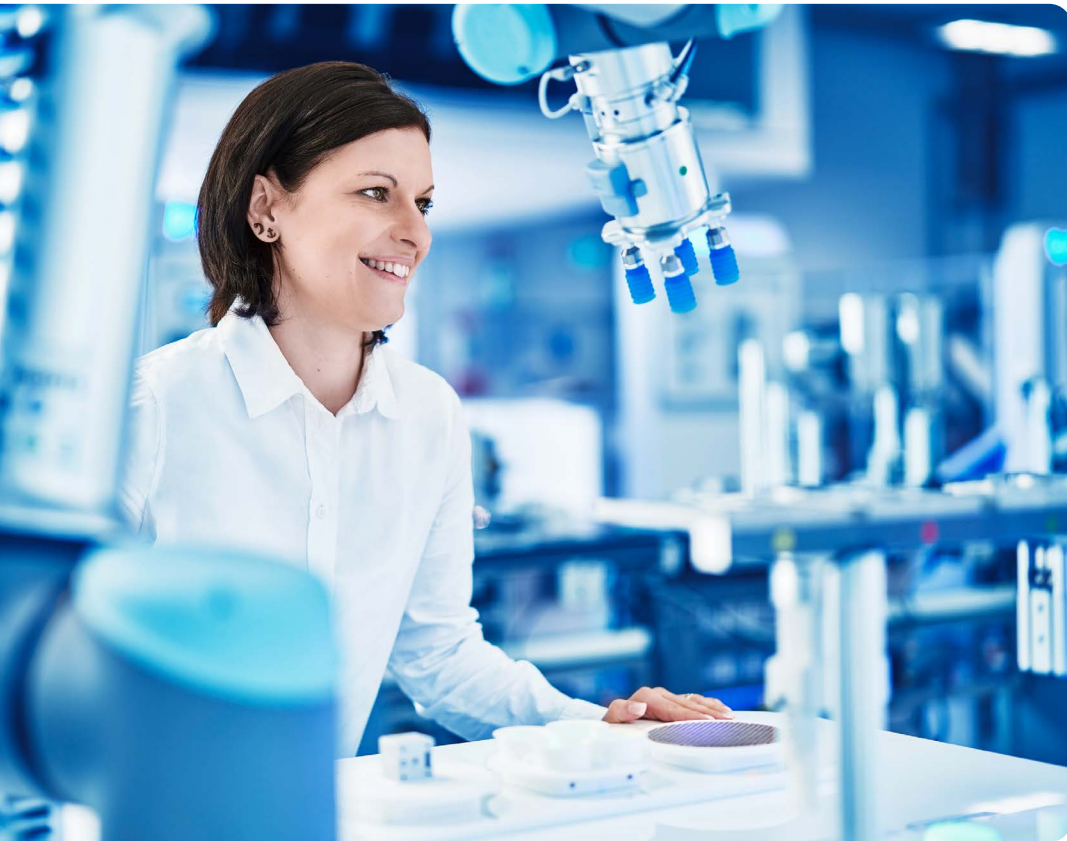

Integrated vacuum solution for box packaging automation

The challenge

A supermarket warehouse was developing a packaged **box loading system using a collaborative robot** for their 24/7 warehouse operations. Each line of the packaging process consisted of three steps:

- 1** Adsorption for box erecting
- 2** Picking up the bagged product and placing it into the box
- 3** Conveying the filled box to a waiting conveyor.

SMC supported the design phase by providing a **unified solution for all vacuum functions, including valves, ejectors and sensors**. For the box-stretching application, a system with 32 **ZP3P-JT series** vacuum pads was implemented to ensure durability throughout the stretching and folding cycles. For box handling, a **ZGS series** vacuum pad unit was selected due to its versatility.

Results

With our expertise and technical support, the company successfully developed a **versatile and durable handling system, achieving maximum performance** in its packaging and handling process.

Improved versatility for conveyor format changes with electrical actuators

The challenge

A semiconductor cassette logistics facility was facing challenges in its conveyor systems due to **variability in product sizes across different models**.

The pneumatic stoppers used for product transfer limited system flexibility, requiring dedicated solutions for each product dimension. To address this issue, SMC proposed **replacing pneumatically controlled stoppers with electric actuators**, such as **LEB series**, which can accommodate multiple positions for differing model sizes and significantly reduce the person-hours associated with jig changes.

In addition, the facility required a **mechanism to adjust the conveyor width to support different product formats**. With support from our application experts, an **LER series electric rotary table** was implemented to reposition the conveyor bars accordingly.

Results

The integration of a fieldbus communication system using PROFINET enabled simple and reliable control from the PLC, allowing **flexible format changes with minimal human intervention**. Additionally, all speed and force movements could also be finely adjusted and controlled. Following the implementation of electric actuators, the facility achieved lower maintenance and changeover costs, resulting in **improved productivity and overall logistics efficiency**.



SMC Business Continuity Plan

Sustainable growth also means ensuring uninterrupted operations

We are committed to ensuring that SMC is prepared for any emergency and that our business activities will not stop in the event of such circumstances. SMC aims to fulfil our product supply responsibilities and maintain our customers' trust by contributing to both sustainable growth and the expansion of technological innovations.

SMC, as a comprehensive manufacturer of automatic control equipment that supports automation, is able to promptly provide products that meet our customers' needs anywhere in the world.

Production BCP

Ensure customer order fulfilment

Reliable delivery for you thanks to our 9 global logistic centres and 38 production sites worldwide. Moreover, flexibility to rapidly respond to any sudden change in the manufacturing environment.

Finance BCP

Safe & Solid financial base

In the event of an emergency, SMC can provide a safe and solid financial base (with cash, deposits, and equity capital) that will sufficiently cover the working capital and funds needed to rebuild buildings and the equipment required for business continuity. This is done to provide peace of mind to our customers and workers alike.

Information security BCP

Vital data kept safe

Strengthen information security for protection against computer viruses and cyberattacks, plus the installation of data centres to establish a disaster recovery system. Your information is safe with us.

Engineering BCP

Consistent technical support

2,000 engineers at our 5 technical centres around the globe.

Sales BCP

Consistent sales support

7,000 sales engineers worldwide ready to recommend the best solution for you. Over 80 global locations to make sure that wherever you are, we are there too.

[+ Discover more](#)



SMC Corporation

1-5-5, Kyobashi,
Chuo-ku, Tokyo
104-0031, Japan
Telephone: 03-6628-3000
<https://www.smcworld.com>

Austria	+43 (0)2262622800	www.smc.at	office.at@smc.com						
Belgium	+32 (0)33551464	www.smc.be	info@smc.be						
Bulgaria	+359 (0)2807670	www.smc.bg	sales.bg@smc.com						
Croatia	+385 (0)13707288	www.smc.hr	sales.hr@smc.com						
Czech Republic	+420 541424611	www.smc.cz	office.at@smc.com						
Denmark	+45 70252900	www.smc.dk	smc.dk@smc.com						
Estonia	+372 651 0370	www.smcee.ee	info.ee@smc.com						
Finland	+358 207513513	www.smc.fi	smc.fi@smc.com						
France	+33 (0)164761000	www.smc-france.fr	supportclient.fr@smc.com						
Germany	+49 (0)61034020	www.smc.de	info.de@smc.com						
Greece	+30 210 2717265	www.smchellas.gr	sales@smchellas.gr						
Hungary	+36 23513000	www.smc.hu	office.hu@smc.com						
Ireland	+353 (0)14039000	www.smcautomation.ie	technical.ie@smc.com						
Italy	+39 03990691	www.smcitalia.it	mailbox.it@smc.com						
Latvia	+371 67817700	www.smc.lv	info.lv@smc.com						
Lithuania	+370 5 2308118	www.smclt.lt	info.lt@smc.com						
Netherlands	+31 (0)205318888	www.smc.nl	info@smc.nl						
Norway	+47 67129020	www.smc-norge.no	post.no@smc.com						
Poland	+48 22 344 40 00	www.smc.pl	office.pl@smc.com						
Portugal	+351 214724500	www.smc.eu	apoiocliente.pt@smc.com						
Romania	+40 213205111	www.smcromania.ro	office.ro@smc.com						
Russia	+7 (812)3036600	www.smc.eu	sales@smcru.com						
Slovakia	+421 (0)413213212	www.smc.sk	sales.sk@smc.com						
Slovenia	+386 (0)73885412	www.smc.si	office.si@smc.com						
Spain	+34 945184100	www.smc.eu	post.es@smc.com						
Sweden	+46 (0)86031240	www.smc.nu	order.se@smc.com						
Switzerland	+41 (0)523963131	www.smc.ch	helpcenter.ch@smc.com						
Turkey	+90 212 489 0 440	www.smcturkey.com.tr	satis.tr@smc.com						
UK	+44 (0)845 121 5122	www.smc.uk	sales.gb@smc.com						
South Africa	+27 10 900 1233	www.smcza.co.za	Sales.za@smc.com						

www.smc.eu

Release EQ
INTRALOG-01A-EN

SPECIFICATIONS ARE SUBJECT TO CHANGE WITHOUT PRIOR NOTICE AND ANY OBLIGATION ON THE PART OF THE MANUFACTURER