

Moisture Control Tube

New

Prevents condensation in piping

for small cylinders/air grippers.

Diffuses water vapour in the piping to the outside!

New

Linear shape

Suitable for applications where cylinders do not rotate.



Coil shape

Reduces tube buckling of moving part.

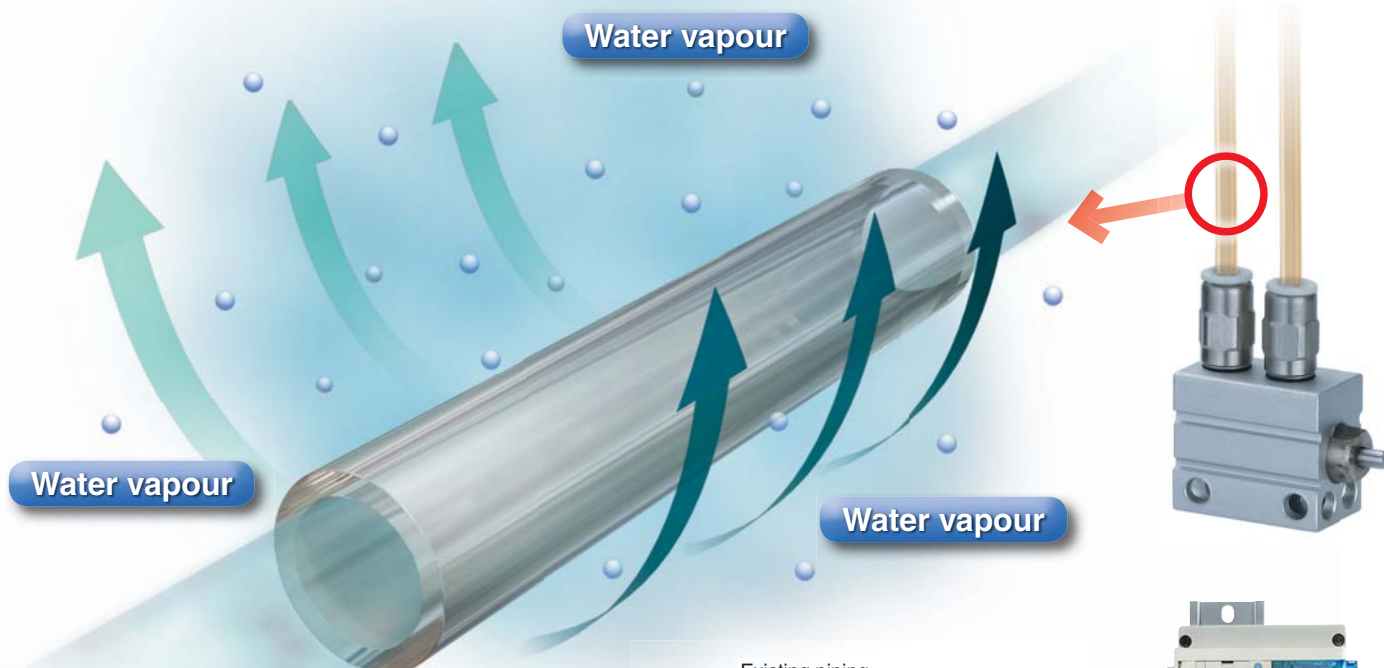

Additional power supply and works are not necessary!

All you have to do is install the moisture control tube!!

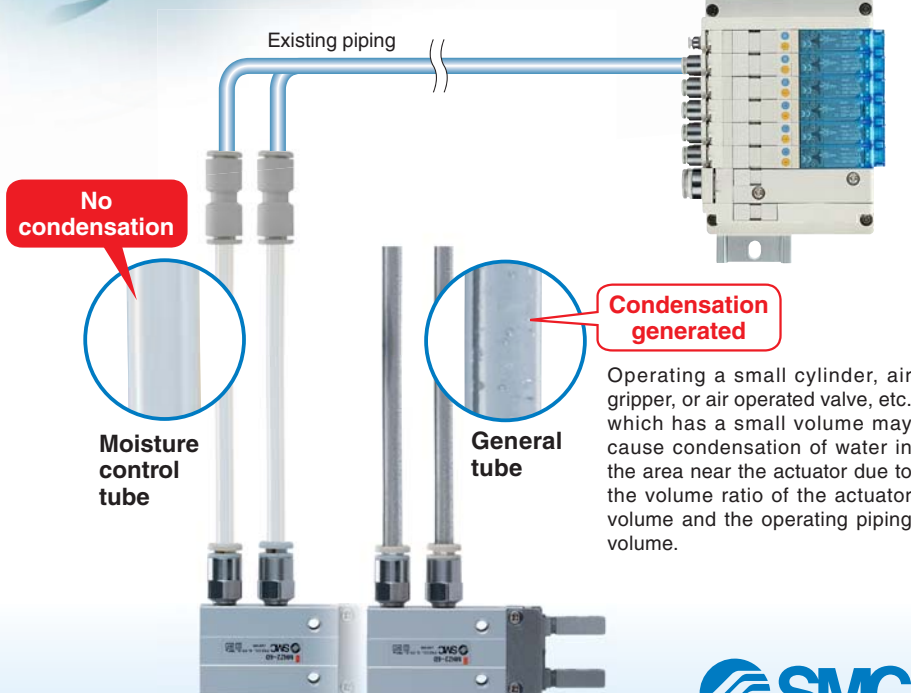

Series **IDK**



CAT.EUS30-12C-UK

Prevents condensation issue with pneumatic equipment.

If condensation occurs...

Grease deteriorates or is washed away.

Operation failure

Shorter life

Air quality affects the operation and the life of the equipment in a pneumatic system, so dehumidified air is necessary. In particular, if small actuators are continuously operated at high frequency, condensation may be generated even with dehumidified air, due to the characteristics of the system. The moisture control tube prevents condensation from being formed by diffusing water vapour generated in the piping to the outside before the water vapour is condensed.

Supply

The mechanism of condensation in small actuators

Exhaust

- ① The temperature in the piping rapidly drops due to adiabatic expansion.
- ② If the temperature in the piping becomes lower than the dew point of the compressed air, vapour will be generated.
- ③ The vapour cannot be exhausted (cannot be pushed out) as the volume of the actuator is small.

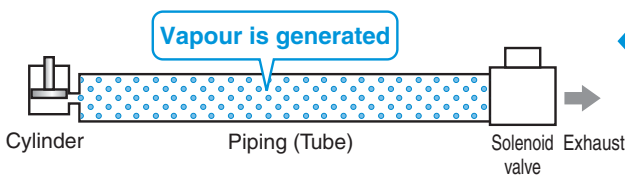

Supply

Residual vapour is pressed by compressed air and accumulates in the area near the actuator.

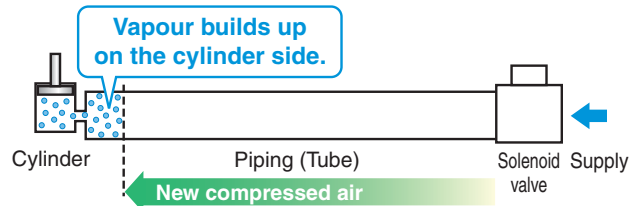

Equipment in which condensation is a possibility

Small diameter cylinders/air grippers



Air operated valves (Pilot port)

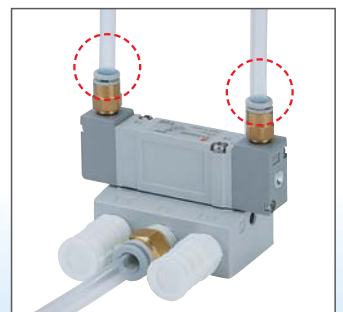

**Additional power supply and works are not necessary!
Just by installing the moisture control tube prevents condensation.**

Linear shape

Suitable for applications where cylinders do not rotate.

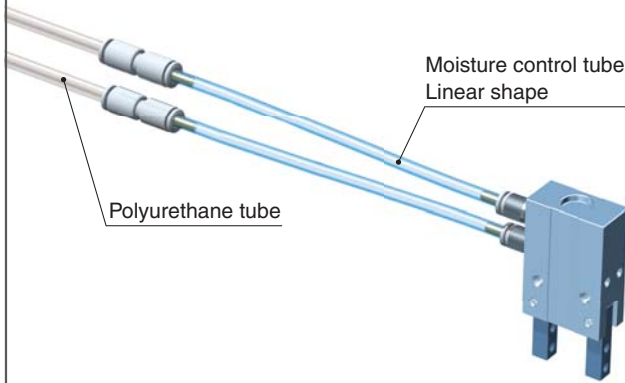

Model	Tube O.D.	Tube effective length	
		100	200
IDK02	Ø 2	●	●
IDK04	Ø 4	●	●
IDK06	Ø 6	●	●

Coil shape New

Since other tubes with a small bending radius are used on moving parts, the buckling trouble of the moisture control tubes can be reduced.

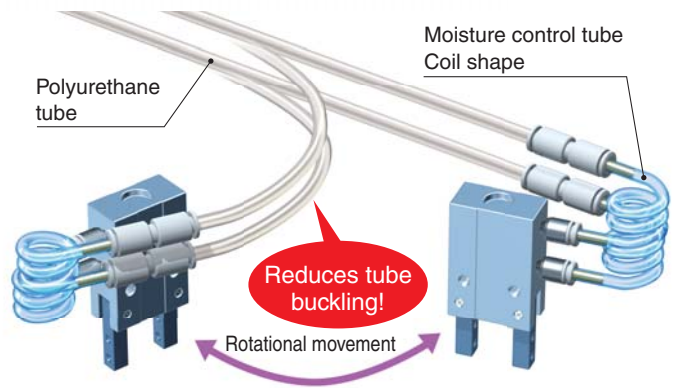

Model	Tube O.D.	Tube effective length	
		100	200
IDK04	Ø 4	●	●
IDK06	Ø 6	●	●

The accumulated vapour is liquefied (condensed) due to repeated supply/exhaust.

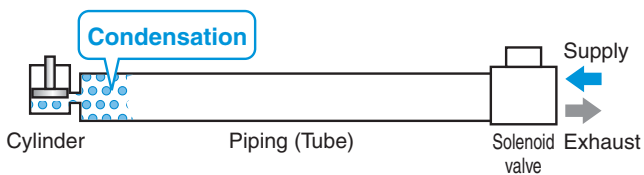

Water droplets

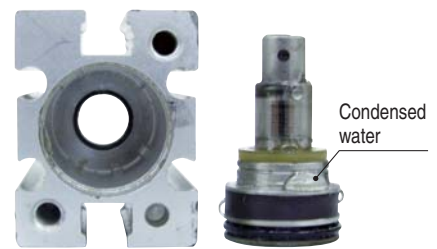

Grease deteriorates or is washed away.

Operating principle of moisture control tube

This moisture control tube has characteristics to balance the humidity inside the tube with that outside the tube. If the humidity inside the tube differs from that outside the tube, the moisture control tube penetrates the water vapour from the higher humidity side to the lower humidity side. The moisture control tube penetrates only the water vapour and rarely penetrates the air. The humidity inside the tube is put in the high humidity status due to the mist generated every exhaust, causing dew condensation. The moisture control tube penetrates the generated mist from the inside of the tube with a high humidity to its outside with a low humidity to prevent accumulation of water vapour and dew condensation inside the tube.

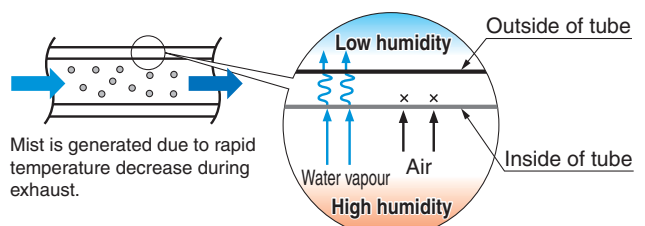

The water vapour is generated and it moves from the inside of the tube with a high humidity to its outside with a low humidity.

Moisture Control Tube Series *IDK*



Specifications (Linear Shape)

Model	IDK02	IDK04	IDK06
Fluid	Compressed air		
Max. operating pressure	0.7 MPa		
Installation temperature/ Relative humidity	40 °C / 75 % RH or less		
Temperature	0 to 60 °C (No freezing)		
Operating environment*1	Indoors, where product is not exposed to water (0 to 40 °C, Relative humidity 0 to 75 %RH)		
Min. bending radius*2 [mm]	10	20	40
O.D. [mm]	2	4	6
I.D. [mm]	1.2	2.5	4
Inner sleeve I.D. [mm]	0.8	2.1	3.4
Quantity of moisture control tubes	2 pcs.		
Colour	Transparent [Colour will change to brown over time, but the functions are not affected.]		
Applicable fittings	KQ2		
Material	Fluoropolymer		

Note 1) Use the moisture control tube in a line with a refrigerated air dryer and a mist separator installed in the upstream compressed air line. The condensation prevention performance may be lowered depending on the quality of the supply compressed air (oil, dew point).

Note 2) The inner sleeve is already mounted and cannot be removed. If the inner sleeve comes off, re-insert the sleeve before mounting the fitting.

Note 3) Do not cut the tube.

*1 Use the product in an operating environment where humidity is as low as possible.

*2 The value at which the moisture control tube is bent or flattened at 20 °C. Be careful not to bend or flatten the tube and the inner sleeve even if the value is more than the minimum bending radius.

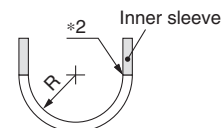

How to Order

IDK 02 - 100

• Tube O.D. •

Symbol	O.D.
02	2 mm
04	4 mm
06	6 mm

• Tube effective length

Symbol	Effective length
100	100 mm
200	200 mm

Dimensions

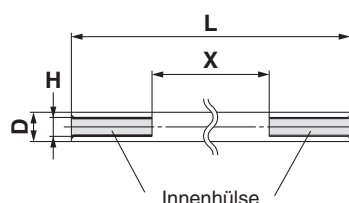

Model	O.D. x I.D. D	Inner sleeve I.D. H	Nominal effective length X	Unit: mm
				Full length L
IDK02-100	2 x 1.2	0.8	100	120
IDK02-200				220
IDK04-100	4 x 2.5	2.1	100	140
IDK04-200				240
IDK06-100	6 x 4	3.4	100	140
IDK06-200				240

Note) Dimensions at 40 % relative humidity.
Dimensions may change if the relative humidity changes.

Made to Order

If you require the moisture control tube with an effective length not listed in the above table, please contact SMC.

Specifications (Coil Shape)



Model	IDK04-□-C1	IDK06-□-C1
Fluid	Compressed air	
Max. operating pressure	0.7 MPa	
Fluid temperature	0 to 60 °C (No freezing)	
Ambient temperature	0 to 40 °C, Relative humidity 0 to 75 % RH	
Operating environment*1	Indoors, where product is not exposed to water (0 to 40 °C, Relative humidity 0 to 75 % RH)	
O.D. [mm]	4	6
I.D. [mm]	2.5	4
Inner sleeve I.D. [mm]	2.1	3.4
Tube effective length*2 [mm]	100, 200	
Quantity of moisture control tubes	2 pcs.	
Colour	Transparent (Colour will change to brown over time, but the functions are not affected.)	
Applicable fittings	KQ2	
Material	Fluoropolymer	

Note 1) Use the moisture control tube in a line with a refrigerated air dryer and a mist separator installed in the upstream compressed air line. The condensation prevention performance may be lowered depending on the quality of the supply compressed air (oil, dew point).

Note 2) The inner sleeve is already mounted and cannot be removed. If the inner sleeve comes off, re-insert the sleeve before mounting the fitting.

Note 3) Do not cut the tube.

*1 Use the product in an operating environment where humidity is as low as possible.

*2 The length when the tube is straight. This effective length is made into a coil shape.

How to Order

IDK 04 - 100 - C1

Tube O.D.

Symbol	O.D.
04	4 mm
06	6 mm

Coil shape

Tube effective length

Symbol	Effective length
100	100 mm
200	200 mm

Note) Part number for a set of 2 tubes

Dimensions (per tube)

IDK04-100-C1

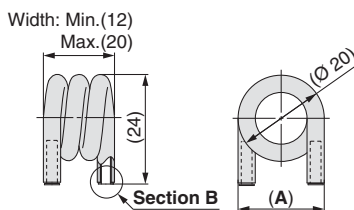

IDK04-200-C1

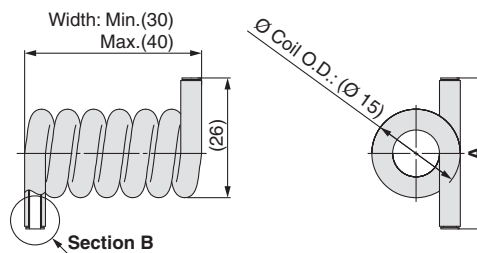

IDK06-100-C1

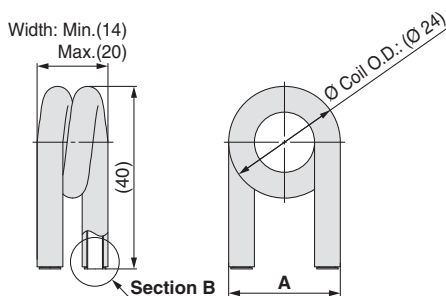

IDK06-200-C1

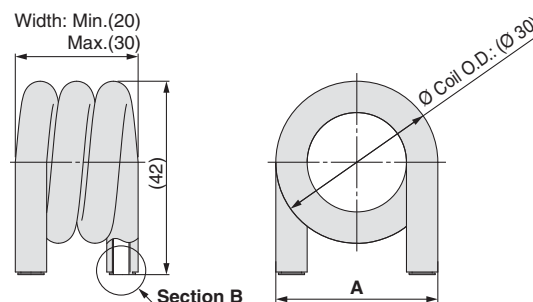

Section B details

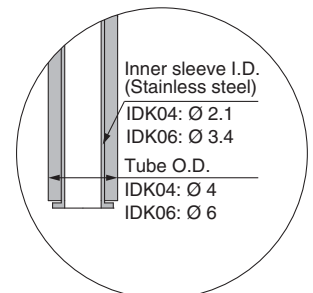

* Due to the material, the above dimensions may vary depending on the environment (temperature, humidity) including the spread of dimension A.

Series IDK

Table for Quick Selection

Refer to pages 7 and 8 for details of Model Selection.



Basic conditions for selection

- Compressed air pressure: 0.5 MPa
- Compressed air dew point: -20 °C (Atmospheric pressure dew point)
- Ambient air environment: Temperature 25 °C, Humidity 40 %
- * If your operating conditions are different from these basic conditions, correct them based on "Model Selection".

Single Piston

Actuator size		Piping condition Tube length [m]	Recommended model					
Bore size [mm]	Stroke [mm]		Tube O.D. 2 mm		Tube O.D. 4 mm		Tube O.D. 6 mm	
			IDK02-100	IDK02-200	IDK04-100 (-C1)	IDK04-200 (-C1)	IDK06-100 (-C1)	IDK06-200 (-C1)
2.5	All strokes	5	●	—	—	●	—	●
		10	●	—	—	●	—	●
4	All strokes	5	●	—	—	●	—	●
		10	●	—	—	●	—	●
6	Less than 10	5	●	—	—	●	—	●
		10	●	—	—	●	—	●
	10 or more	5	●	—	●	—	—	●
		10	●	—	●	—	—	●
8	Less than 10	5	●	—	●	—	—	●
		10	●	—	—	●	—	●
	10 or more	5	●	—	●	—	●	—
		10	●	—	●	—	—	●
10	Less than 10	5	●	—	●	—	●	—
		10	●	—	●	—	—	●
	10 or more	5	●	—	●	—	●	—
		10	●	—	●	—	●	—
16 (15)	Less than 10	5	●	—	●	—	●	—
		10	●	—	●	—	●	—
	10 or more	5	●	—	●	—	●	—
		10	●	—	●	—	●	—
20	Less than 10	5	●	—	●	—	●	—
		10	●	—	●	—	●	—
	10 or more	5	●	—	●	—	●	—
		10	●	—	●	—	●	—



Dual Piston

Series	Actuator size		Piping condition Tube length [m]	Recommended model					
	Bore size [mm]	Stroke [mm]		Tube O.D. 2 mm		Tube O.D. 4 mm		Tube O.D. 6 mm	
				IDK02-100	IDK02-200	IDK04-100 (-C1)	IDK04-200 (-C1)	IDK06-100 (-C1)	IDK06-200 (-C1)
CXWM, CXWL (CXW□-25 or less)	10	25	5	—	—	—	—	—	—
			10	—	—	—	—	●	—
MXQ	6	10	5	●	—	●	—	●	—
			10	●	—	●	—	—	●
	Size larger than those above	5	●	—	●	—	●	—	
		10	●	—	●	—	●	—	
CXS, CXSJ	6	10	5	●	—	●	—	●	—
			10	●	—	●	—	—	●
	Size larger than those above	5	●	—	●	—	●	—	
		10	●	—	●	—	●	—	

Note) If the piping is longer than the above tube length, the IDK□-200 may be necessary.

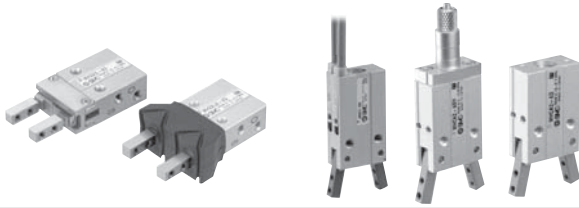

Basic conditions for selection

- Compressed air pressure: 0.5 MPa
- Compressed air dew point: -20 °C (Atmospheric pressure dew point)
- Ambient air environment: Temperature 25 °C, Humidity 40 %
- * If your operating conditions are different from these basic conditions, correct them based on "Model Selection".

Air Gripper

Series	Bore size [mm]	Piping condition Tube length [m]	Recommended model					
			Tube O.D. 2 mm		Tube O.D. 4 mm		Tube O.D. 6 mm	
			IDK02-100	IDK02-200	IDK04-100 (-C1)	IDK04-200 (-C1)	IDK06-100 (-C1)	IDK06-200 (-C1)
MHZA2, MHZAJ2	6	5	●	—	●	—	—	●
		10	●	—	●	—	—	●
MHZ2, MHZJ2	6	5	●	—	●	—	●	—
		10	●	—	●	—	—	●
MHC2	6	5	●	—	●	—	—	●
		10	●	—	—	●	—	●
MHCA2	6	5	●	—	—	●	—	●
		10	●	—	—	●	—	●
MHCM2	7	5	●	—	—	●	—	●
		10	●	—	—	●	—	●
Air gripper with bore size larger than those above		—	●	—	●	—	●	—



Rotary Actuator

Series	Vane type	Size	Rotating angle	Piping condition Tube length [m]	Recommended model					
					Tube O.D. 2 mm		Tube O.D. 4 mm		Tube O.D. 6 mm	
					IDK02-100	IDK02-200	IDK04-100 (-C1)	IDK04-200 (-C1)	IDK06-100 (-C1)	IDK06-200 (-C1)
CRB□ CRBU2	Single	10	90	5	—	—	●	—	●	—
				10	—	—	●	—	●	—
			180	5	—	—	●	—	●	—
				10	—	—	●	—	●	—
			270	5	—	—	●	—	●	—
				10	—	—	●	—	●	—
	Double	10	90	5	—	—	●	—	●	—
				10	—	—	●	—	●	—
			100	5	—	—	●	—	●	—
				10	—	—	●	—	●	—
			90	5	—	—	●	—	●	—
				10	—	—	●	—	●	—
MSU□	Single	1	90	5	—	—	●	—	●	—
				10	—	—	●	—	●	—
			180	5	—	—	—	—	●	—
				10	—	—	●	—	●	—
			90	5	—	—	—	—	●	—
				10	—	—	●	—	●	—
	Double	1	90	5	—	—	●	—	●	—
				10	—	—	●	—	●	—
			90	5	—	—	●	—	●	—
				10	—	—	●	—	●	—
			90	5	—	—	●	—	●	—
				10	—	—	●	—	●	—
CRQ2	—	10	90	5	—	—	●	—	●	—
				10	—	—	●	—	●	—
			180	5	—	—	—	—	●	—
				10	—	—	●	—	●	—
			90	5	—	—	—	—	●	—
				10	—	—	●	—	●	—
MSQ□	—	1	90	5	—	—	●	—	●	—
				10	—	—	●	—	●	—
		2		5	—	—	—	—	●	—
				10	—	—	●	—	●	—
		3		5	—	—	—	—	●	—
				10	—	—	●	—	●	—

Note) If the piping is longer than the above tube length, the IDK□-200 may be necessary.

Series IDK Model Selection

Selection Procedure

1 Check the presence of condensation.

(1) The presence of condensation can be verified by the dew point and Kv value (the volume ratio of tube and actuator) of the supply air.

Fig. 1 Verification Chart of Condensation

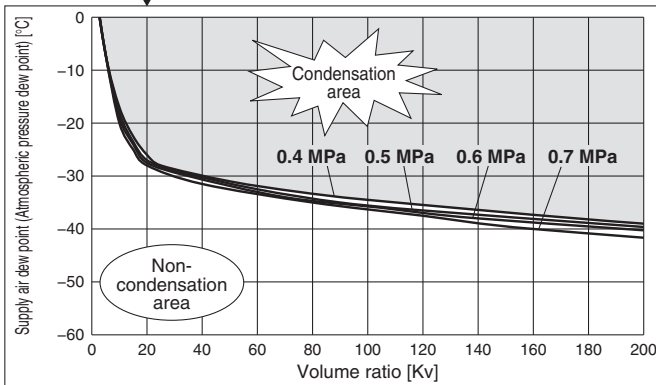
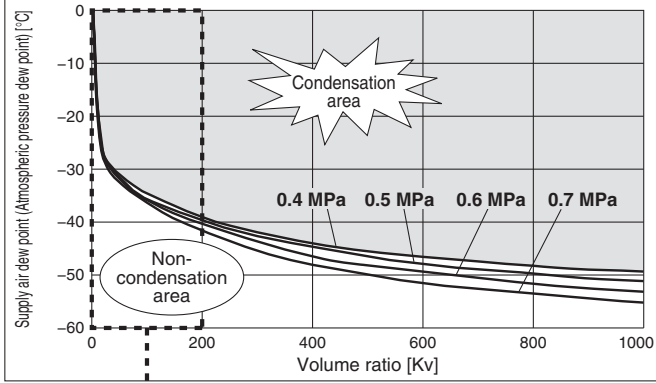

Calculation method of volume ratio (Kv value)

Calculate the piping volume V_t and the actuator volume V_c and substitute them into equation ① below.

$$Kv = \frac{V_t}{V_c} \dots \textcircled{1}$$

Kv : Volume ratio
 V_t : Piping volume [mm³]
 V_c : Actuator volume [mm³]

$$V_t = \frac{\pi d^2 l}{4}$$

V_t : Piping volume [mm³] [can be selected from piping volume chart in Fig. 2.]

d : Tube I.D. [mm]

l : Tube piping length [mm]

* Tube length means the length from the switch valve (e.g. solenoid valve) to the actuator.

$$V_c = \frac{\pi D^2 s}{4}$$

V_c : Actuator volume [mm³]

D : Bore size [mm]

s : Stroke [mm]

Fig. 2 Piping Volume Chart

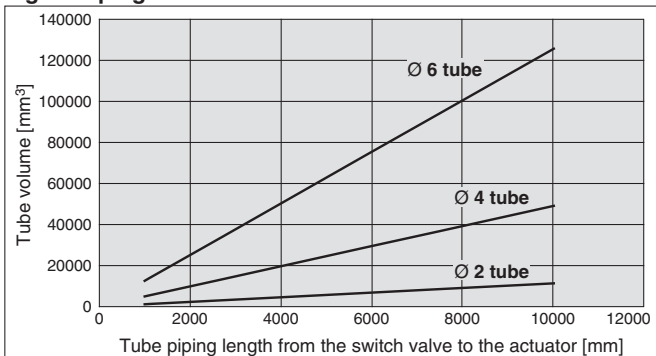

2 Select the length of moisture control tube for the condensation area.

(1) Find L , the necessary length corresponding to the Kv value, from the length selection chart at basic conditions.

Fig. 3 Length Selection Chart at Basic Conditions

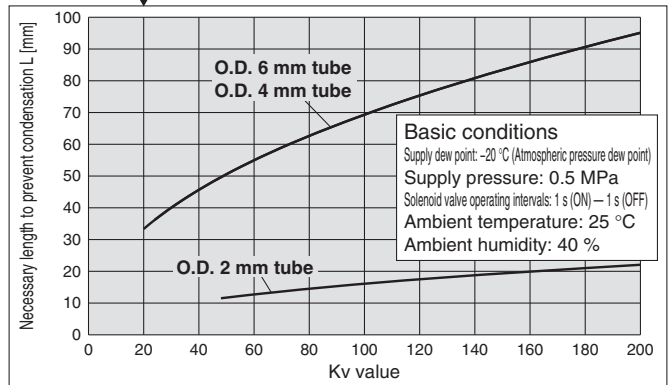
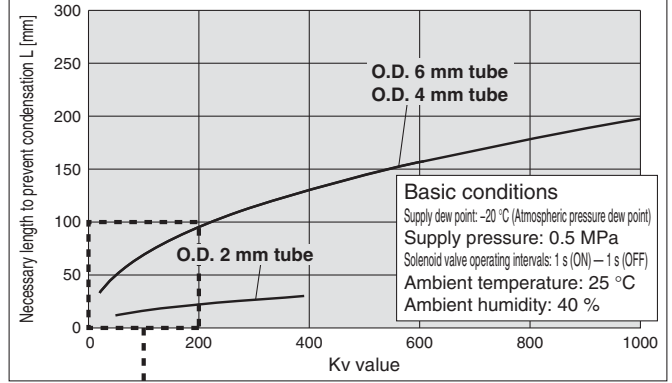

(2) If your operating conditions are different from these basic conditions, apply a correction factor.

Necessary effective length = Basic condition length L x Correction factor C_1 x C_2 x C_3

Correction Factor C_1 for Supply Air Dew Point

Supply air dew point [°C]	Correction factor C_1
-10	2
-20	1
-30	0.5
-40	0.25

Correction Factor C_2 for Ambient Air Relative Humidity

Relative humidity	Temperature		
	10 °C	25 °C	40 °C
20 %	0.2	0.4	0.6
40 %	0.5	1.0	1.3
60 %	1.0	1.7	2.8
75 %	2.1	4.0	5.9

Correction Factor C_3 for Supply Pressure

Supply pressure [MPa]	Correction factor C_3
0.3	0.4
0.4	0.7
0.5	1
0.6	1.25
0.7	1.6

Selection Example

Circuit conditions

- Actuator : CUJB4-6D
- Bore size **D**: 4 mm
- Stroke **s**: 6 mm
- Tube size : O.D. 6 mm x I.D. (d) 4 mm
- Tube piping length **l**: 5 m
- Supply air pressure : 0.3 MPa
- Supply air dew point : -20 °C (Atmospheric pressure dew point)
- Ambient environment: Temperature 25 °C, Humidity 60 %

1 Check the presence of condensation.

Check the presence of condensation.

(1) Calculation method of volume ratio (Kv value)

$$V_t = \frac{\pi d^2 l}{4} = \frac{\pi \times 4^2 \times 5000}{4} = 62800 \text{ mm}^3$$

$$V_c = \frac{\pi D^2 s}{4} = \frac{\pi \times 4^2 \times 6}{4} = 75 \text{ mm}^3$$

$$K_v = \frac{V_t}{V_c} = 837$$

Note) For dual piston cylinder, the volume ratio will be 1/2 of the volume ratio calculated above.

Verify the presence of condensation.

(2) Refer to the verification chart of condensation.

Check whether the volume ratio [Kv] and the supply air dew point intersect in the condensation area.
With the conditions above, they intersect in the condensation area, meaning **condensation will occur**.

Fig.1 Verification Chart of Condensation

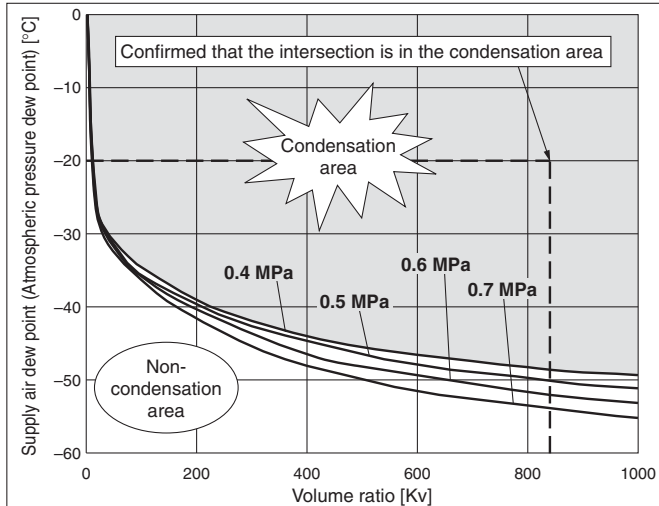

2 Select the length of moisture control tube.

(1) Find the necessary length L from the length selection chart at basic conditions and Kv value.

Fig. 2 Length Selection Chart at Basic Conditions

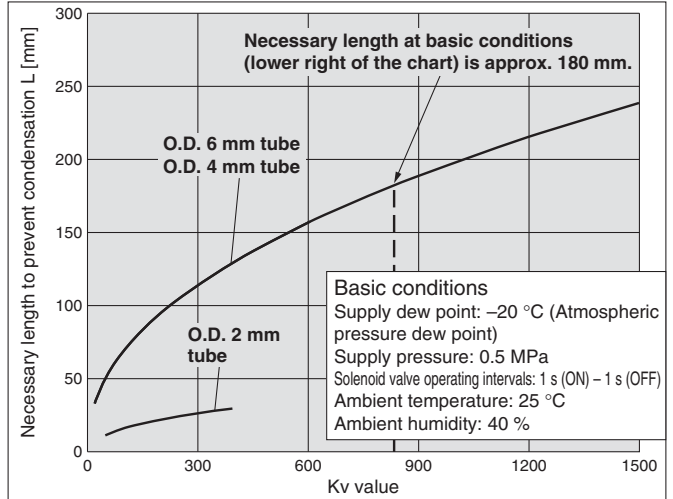

(2) If your operating conditions are different from these basic conditions, apply a correction factor.

Necessary effective length = Basic condition length L x Correction factor C1 x C2 x C3

In the example circuit, the conditions which are different from the basic conditions are:

- Supply dew point: -20 °C (Atmospheric pressure dew point) * Basic conditions Supply dew point: -20 °C (Atmospheric pressure dew point)
- Supply pressure: 0.3 MPa (Atmospheric pressure dew point) Supply pressure: 0.5 MPa
- Ambient environment: 25 °C, 60 % Ambient temperature: 25 °C Ambient humidity: 40 %

- (a) Find the correction factors.
- Supply air dew point correction factor **C1 = 1**
 - Ambient air dew point correction factor **C2 = 1.7**
 - Supply pressure correction factor **C3 = 0.4**
- (b) Find the necessary effective length after correction.

Necessary effective length = 180 x 1 x 1.7 x 0.4 ≈ 120 mm

Therefore, the moisture control tube **IDK06-200** with effective length 20 cm should be used.

Correction Factor C1 for Supply Air Dew Point

Supply air dew point [°C]	Correction factor C1
-10	2
-20	1
-30	0.5
-40	0.25

Correction Factor C2 for Ambient Air Relative Humidity

Relative humidity	Temperature			
	10 °C	25 °C	40 °C	60 °C
20 %	0.2	0.4	0.6	0.8
40 %	0.5	1.0	1.3	1.8
60 %	1.0	1.7	2.8	3.7
80 %	2.1	4.0	5.9	7.8

Correction Factor C3 for Supply Pressure

Supply pressure [MPa]	Correction factor C3
0.3	0.4
0.4	0.7
0.5	1
0.6	1.25
0.7	1.6



Series IDK

Specific Product Precautions 1

Be sure to read this before handling. Refer to the back cover for Safety Instructions. For Air Preparation Equipment Precautions, refer to "Handling Precautions for SMC Products" and the Operation Manual on the SMC website, <http://www.smc.eu>

Design

⚠ Caution

1. Use the moisture control tube without lubrication.
2. Do not cover the moisture control tube or use in an enclosed space. Water vapour escapes outside of the moisture control tube.
Covering the moisture control tube will reduce the performance and condensation cannot be prevented.
3. The moisture control tube is for indoor use. It cannot be used under water or where it is exposed to water.
4. The exterior dimensions will change depending on the relative humidity. If the moisture control tube is left for a long period of time in an environment which exceeds the operating range, the outer diameter will increase and it will become difficult to insert and remove it from the One-touch fitting. If it is left in a dry state, the dimensions will return to the original dimensions, but the performance will not be affected.
5. The outer diameter will increase during operation and it may become difficult to pull out. In order to remove the tube, wait for a while after the operation has stopped.
6. The colour of the moisture control tube will turn to brown over time due to reaction with organic substances in the air. This does not affect the performance or strength.
7. Do not wipe or clean the product with alcohol. The product should only be cleaned by air-blow.
8. The moisture control tube is assumed to be used for static piping.
If the tube moves, for example in a flexible moving tube, it may become worn, elongated or torn due to tensile forces, or disconnected from the fitting. Ensure the tube is in a static condition at all times before using.
9. Do not use this product in locations where there are problems with static electricity.
10. Do not use this product in locations where spatter is generated.
11. Do not use in an environment where the product is directly exposed to cutting oil, lubricant, coolant oil, etc.
12. Do not use in environments where foreign matter may stick to the product or get mixed in the product's interior.

Mounting

⚠ Caution

1. Do not use the moisture control tubes bundled together.
Otherwise, the performance may be decreased.
2. Connect the tube directly to the fitting of the actuator or air operated valve.
If the tube is connected to other places, condensation will not be prevented and vapour will be generated.

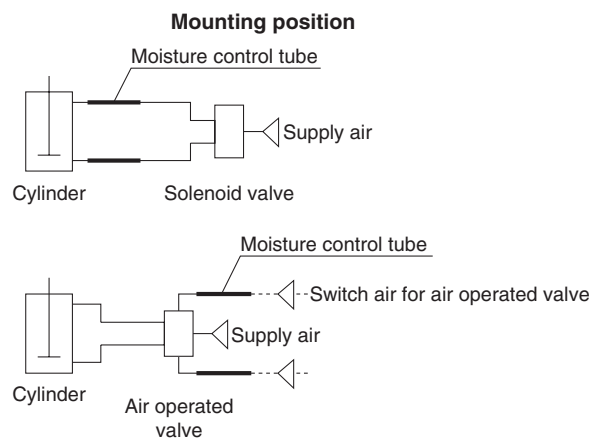

3. Clean the tube and actuator by air blowing to eliminate moisture before connecting them to the circuit with condensation.

⚠ Caution

If the moisture control tube is mounted to an actuator where condensation has been generated, it is possible that the grease has been washed away. Make sure to add grease to the actuator based on the maintenance procedure of the actuator.

4. Mount the tube with minimum bending radius or more. Be careful not to bend or flatten the tube even if the bending radius is more than the minimum value. The moisture control tube is not suitable for the place where the product slides in high frequency.
Do not stretch or shake this product when using. The IDK0□-□00-C1 is the IDK0□-□00 with a coil shape, so the performance is the same.
When connecting this product to a fitting, hold the tube and slowly push the tube straight (0 to 5°) into the fitting until it stops. Pull the tube back gently to make sure that it is connected firmly. If the tube is not installed correctly, it may cause air leaks, or the tube may be disconnected.
As a guide, connect the tube to the fitting until the inner sleeve is not visible from the fitting.



Series IDK

Specific Product Precautions 2

Be sure to read this before handling. Refer to the back cover for Safety Instructions. For Air Preparation Equipment Precautions, refer to "Handling Precautions for SMC Products" and the Operation Manual on the SMC website, <http://www.smc.eu>

Operating Environment

⚠ Caution

1. Avoid high temperature and humidity in the operating environment. They affect the performance of the tube and condensation may be generated.

Installation

⚠ Caution

1. Install a refrigerated air dryer and a mist separator in the compressed air line. The condensation prevention performance may be lowered depending on the quality of the supply compressed air (oil, dew point).

Recommended Model

Description	Model
Refrigerated air dryer	IDF/IDU
Mist separator	AM/AFM

2. Select the moisture control tube with the same diameter as the tube connected.

Example) TU0604 → IDK06-□00

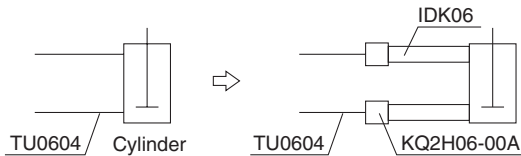

* One-touch fitting (KQ2H06-00A) is not included.

3. The inner sleeve is already mounted. It cannot be removed. If the inner sleeve comes off, re-insert the inner sleeve into the tube again before mounting it to the fitting.
4. Do not cut the moisture control tube.



Others

⚠ Caution

1. The moisture control tube is a product to prevent condensation of actuating parts such as small actuators and air operated valves. If you wish to use the product for any other application, please contact SMC.
2. Applicable fittings: One-touch fittings KQ2, KJ. Other types of fittings must not be used.
3. Store the moisture control tube without unpacking. After unpacking the product, store it at a temperature of 40 °C or less and relative humidity of 75 % or less.
4. When the moisture control tube (coil shape) is stored or used for long periods, the dimensions and shape may change. Note that the shape of this product tends to change easily, particularly in high temperature and humidity environments.

Safety Instructions

These safety instructions are intended to prevent hazardous situations and/or equipment damage. These instructions indicate the level of potential hazard with the labels of “Caution,” “Warning” or “Danger.” They are all important notes for safety and must be followed in addition to International Standards (ISO/IEC)*1), and other safety regulations.

-  **Caution:** Caution indicates a hazard with a low level of risk which, if not avoided, could result in minor or moderate injury.
-  **Warning:** Warning indicates a hazard with a medium level of risk which, if not avoided, could result in death or serious injury.
-  **Danger:** Danger indicates a hazard with a high level of risk which, if not avoided, will result in death or serious injury.

- *1) ISO 4414: Pneumatic fluid power – General rules relating to systems.
- ISO 4413: Hydraulic fluid power – General rules relating to systems.
- IEC 60204-1: Safety of machinery – Electrical equipment of machines. (Part 1: General requirements)
- ISO 10218-1: Manipulating industrial robots - Safety. etc.

Warning

1. The compatibility of the product is the responsibility of the person who designs the equipment or decides its specifications.

Since the product specified here is used under various operating conditions, its compatibility with specific equipment must be decided by the person who designs the equipment or decides its specifications based on necessary analysis and test results. The expected performance and safety assurance of the equipment will be the responsibility of the person who has determined its compatibility with the product. This person should also continuously review all specifications of the product referring to its latest catalogue information, with a view to giving due consideration to any possibility of equipment failure when configuring the equipment.

2. Only personnel with appropriate training should operate machinery and equipment.

The product specified here may become unsafe if handled incorrectly. The assembly, operation and maintenance of machines or equipment including our products must be performed by an operator who is appropriately trained and experienced.

3. Do not service or attempt to remove product and machinery/equipment until safety is confirmed.

1. The inspection and maintenance of machinery/equipment should only be performed after measures to prevent falling or runaway of the driven objects have been confirmed.
2. When the product is to be removed, confirm that the safety measures as mentioned above are implemented and the power from any appropriate source is cut, and read and understand the specific product precautions of all relevant products carefully.
3. Before machinery/equipment is restarted, take measures to prevent unexpected operation and malfunction.

4. Contact SMC beforehand and take special consideration of safety measures if the product is to be used in any of the following conditions.

1. Conditions and environments outside of the given specifications, or use outdoors or in a place exposed to direct sunlight.
2. Installation on equipment in conjunction with atomic energy, railways, air navigation, space, shipping, vehicles, military, medical treatment, combustion and recreation, or equipment in contact with food and beverages, emergency stop circuits, clutch and brake circuits in press applications, safety equipment or other applications unsuitable for the standard specifications described in the product catalogue.
3. An application which could have negative effects on people, property, or animals requiring special safety analysis.
4. Use in an interlock circuit, which requires the provision of double interlock for possible failure by using a mechanical protective function, and periodical checks to confirm proper operation.

Limited warranty and Disclaimer/ Compliance Requirements

The product used is subject to the following “Limited warranty and Disclaimer” and “Compliance Requirements”. Read and accept them before using the product.

Limited warranty and Disclaimer

1. The warranty period of the product is 1 year in service or 1.5 years after the product is delivered, whichever is first.*2) Also, the product may have specified durability, running distance or replacement parts. Please consult your nearest sales branch.
2. For any failure or damage reported within the warranty period which is clearly our responsibility, a replacement product or necessary parts will be provided. This limited warranty applies only to our product independently, and not to any other damage incurred due to the failure of the product.
3. Prior to using SMC products, please read and understand the warranty terms and disclaimers noted in the specified catalogue for the particular products.

*2) Vacuum pads are excluded from this 1 year warranty.

A vacuum pad is a consumable part, so it is warranted for a year after it is delivered. Also, even within the warranty period, the wear of a product due to the use of the vacuum pad or failure due to the deterioration of rubber material are not covered by the limited warranty.

Caution

1. The product is provided for use in manufacturing industries.

The product herein described is basically provided for peaceful use in manufacturing industries.

If considering using the product in other industries, consult SMC beforehand and exchange specifications or a contract if necessary.

If anything is unclear, contact your nearest sales branch.

Caution

SMC products are not intended for use as instruments for legal metrology.

Measurement instruments that SMC manufactures or sells have not been qualified by type approval tests relevant to the metrology (measurement) laws of each country. Therefore, SMC products cannot be used for business or certification ordained by the metrology (measurement) laws of each country.

Safety Instructions

Be sure to read “Handling Precautions for SMC Products” (M-E03-3) before using.

SMC Corporation (Europe)

Austria	☎ +43 (0)2262622800	www.smc.at	office@smc.at
Belgium	☎ +32 (0)33551464	www.smcpcneumatics.be	info@smcpcneumatics.be
Bulgaria	☎ +359 (0)2807670	www.smc.bg	office@smc.bg
Croatia	☎ +385 (0)13707288	www.smc.hr	office@smc.hr
Czech Republic	☎ +420 541424611	www.smc.cz	office@smc.cz
Denmark	☎ +45 70252900	www.smc.dk.com	smc@smc.dk.com
Estonia	☎ +372 6510370	www.smcpcneumatics.ee	smc@smcpcneumatics.ee
Finland	☎ +358 207513513	www.smc.fi	smc@smc.fi
France	☎ +33 (0)164761000	www.smc-france.fr	info@smc-france.fr
Germany	☎ +49 (0)61034020	www.smc.de	info@smc.de
Greece	☎ +30 210 2717265	www.smchellas.gr	sales@smchellas.gr
Hungary	☎ +36 23511390	www.smc.hu	office@smc.hu
Ireland	☎ +353 (0)14039000	www.smcpcneumatics.ie	sales@smcpcneumatics.ie
Italy	☎ +39 0292711	www.smcitalia.it	mailbox@smcitalia.it
Latvia	☎ +371 67817700	www.smc.lv	info@smc.lv

Lithuania	☎ +370 5 2308118	www.smclt.lt	info@smclt.lt
Netherlands	☎ +31 (0)205318888	www.smcpcneumatics.nl	info@smcpcneumatics.nl
Norway	☎ +47 67129020	www.smc-norge.no	post@smc-norge.no
Poland	☎ +48 222119600	www.smc.pl	office@smc.pl
Portugal	☎ +351 226166570	www.smc.eu	postpt@smc.smces.es
Romania	☎ +40 213205111	www.smcromania.ro	smcromania@smcromania.ro
Russia	☎ +7 8127185445	www.smc-pneumatik.ru	info@smc-pneumatik.ru
Slovakia	☎ +421 (0)413213212	www.smc.sk	office@smc.sk
Slovenia	☎ +386 (0)73885412	www.smc.si	office@smc.si
Spain	☎ +34 902184100	www.smc.eu	smcromania@smcromania.es
Sweden	☎ +46 (0)86031200	www.smc.nu	post@smc.nu
Switzerland	☎ +41 (0)523963131	www.smc.ch	info@smc.ch
Turkey	☎ +90 212 489 0 440	www.smcpcneumatik.com.tr	info@smcpcneumatik.com.tr
UK	☎ +44 (0)845 121 5122	www.smcpcneumatics.co.uk	sales@smcpcneumatics.co.uk

SMC CORPORATION Akihabara UDX 15F, 4-14-1, Sotokanda, Chiyoda-ku, Tokyo 101-0021, JAPAN Phone: 03-5207-8249 FAX: 03-5298-5362