



SMC SOLUTIONS FOR HIGH VACUUM

# Ensure your system runs at its peak



Expertise  
Passion  
Automation

# SMC solutions for high vacuum

## Advanced high-vacuum solutions for precision manufacturing

SMC's High-Vacuum Equipment is the result of over three decades of dedicated research and development in high-vacuum technology. Originally developed in collaboration with leading scientific institutions such as KEK and synchrotron radiation facilities worldwide, our solutions have evolved to meet the increasingly complex demands of semiconductor manufacturing and other high-tech industries.

Our comprehensive product lineup includes high-performance valves—angle, slit, solenoid and smooth vent—manufactured from aluminium and stainless steel to ensure optimal performance in vacuum chambers. These components are designed to support critical processes such as etching, sputtering, ion implantation and chemical vapour deposition (CVD), offering key advantages including:

- **Low outgassing** for reduced pump load and faster exhaust times
- **Uniform thermal conductivity** for consistent temperature control
- **Minimal contamination** from heavy metals, protecting sensitive substrates
- **Replaceable bellows assemblies** for reduced maintenance costs and waste.

SMC's commitment to quality is reflected in our integrated global production system. With ISO Class 5 cleanrooms, rigorous particle monitoring and advanced inspection protocols, we ensure every product meets the highest cleanliness and reliability standards. Our technical centres across Europe, Asia and North America provide localised technical support and product evaluation.

Whether you're designing new vacuum systems or upgrading existing equipment, SMC offers the reliability, precision and support needed to optimise performance and meet the evolving challenges of advanced manufacturing.



# SMC high-vacuum equipment: supporting semiconductor manufacturing

In semiconductor processing, equipment for etching, sputtering, ion implantation and CVD typically processes wafers and liquid crystal substrates within vacuum chambers.

To meet diverse customer needs, we offer a wide range of valves and transfer valves designed for both vacuum exhaust and atmospheric air supply in such vacuum chambers.



# Vent and solenoid valves

## Smooth vent + XVD Series



Introducing the full amount of supply pressure (Clean air / N<sub>2</sub>) all at once when returning the vacuum chamber to the atmosphere will cause particulates to get into the chamber. To prevent this, after slowly introducing the initial air supply and setting the pressure, switch to the main valve circuit to supply the full amount.

### Initial state

In the initial state, the sub-valve opens and the set amount (needle valve) is slowly supplied into the chamber.

### Main valve circuit

By switching to the main valve circuit, the main valve opens and the full amount is introduced into the chamber.

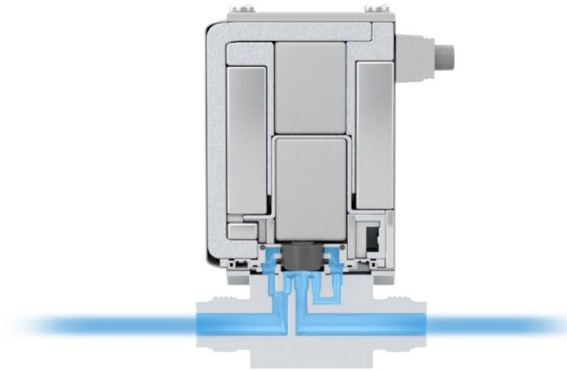
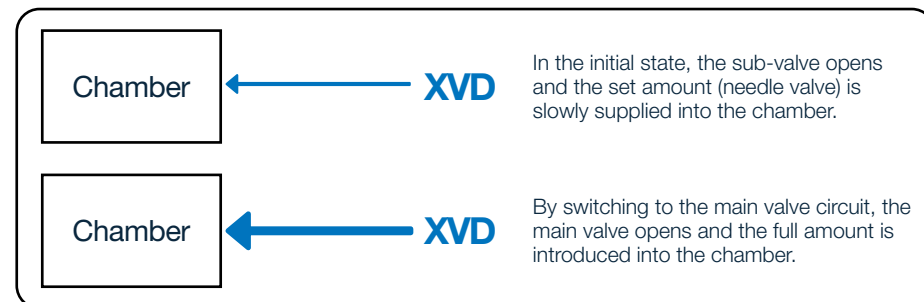

## High-vacuum solenoid valve + XSA Series

Produced in a consistent clean room process, XSA is washed, assembled and inspected in an ISO Class 5 environment, and sealed in double bags.

Highly versatile, it has compression and face seal fittings, a Faston terminal and greater choice of voltages. The spring has also been moved to the XSA's body, reducing contact and minimising particle generation. Corrosion resistant, efficient, economical to operate and lighter in weight: these are all new commercial advantages of the XSA that support our focus on developing innovations to drive energy savings and competitive advantages for customers. It is suitable for applications such as gas injection within the process chamber and when working with inert gases for industries such as food, medical, semiconductor, photovoltaic and LCD.

# Angle and in-line valves

## Precise performance in high-vacuum applications

SMC's angle and in-line valves are engineered to deliver reliable, high-performance flow control in demanding vacuum environments. Designed for use in semiconductor, analytical and industrial applications, these valves offer excellent conductance, low outgassing and high resistance to corrosion—making them ideal for both vacuum exhaust and atmospheric supply lines.

Available in a variety of materials, sizes and configurations, including aluminium and stainless steel options, SMC's valve range supports flexible integration into diverse system layouts. Whether you require compact, lightweight designs or robust solutions for aggressive gases, our angle and in-line valves provide the performance and durability needed for stable, long-term operation.

## Advantages of aluminum alloy valves

### Uniform baking temperature

Excellent thermal conductivity results in a uniform temperature for the entire valve body and a marked decrease in the adhesion of residues inside the valve.

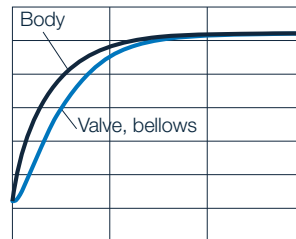

Temperature distribution of the 120 °C specification

**Aluminum**  
(setting temperature of 120 °C)

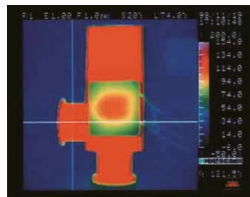

**Stainless steel**  
(setting temperature of 120 °C)

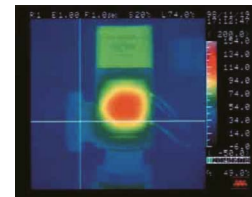

### Low outgassing

Low outgassing makes it possible to use a lower capacity pump and also shorten exhaust time.

### Minimal contamination from heavy metals

The valve does not contain heavy metals such as Ni (nickel) or Cr (chromium), and its low sputtering yield also helps to minimise the heavy metal contamination of semiconductor wafers.

### Lightweight, compact

Large conductance, small body, excellent resistance against fluorine corrosion (body).



### Bellows are replaceable (Bellows seal type)

The bellows assembly can be replaced, which reduces maintenance costs and waste materials.

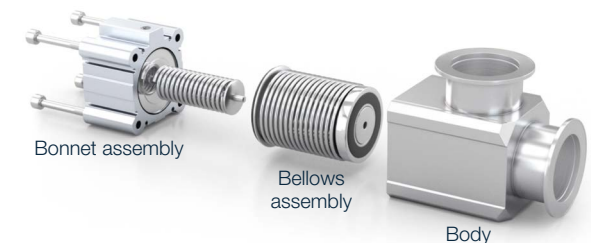

## Valve type

**Angle valves:** Feature a 90° flow path, ideal for compact installations and directional flow control.

**In-line valves:** Provide a straight-through flow path, suitable for systems requiring minimal flow resistance.



⊕ XLA Series



⊕ XLA Series



⊕ XY Series

- Air/Manual operation
- Single/Double acting.

## Shaft seal type

**Bellows seal:** Offers superior vacuum integrity and durability, ideal for ultra-high vacuum applications. These seals are typically used in valves where minimal leakage and long service life are critical.

**O-ring seal:** Suitable for high-vacuum but not ultra-high vacuum conditions. These are easier to maintain and more cost-effective, making them ideal for less demanding environments or where frequent maintenance is expected.



⊕ XLF Series



⊕ XLJ Series



⊕ XLDQ Series

- O-ring shaft seal
- Air/Electromagnetic operation
- Single/Double acting.

## Application suitability

**Bellows seal valves (e.g. XLA-2, XLAV-2, XLC-2):** Recommended for semiconductor processes, clean environments and applications requiring minimal contamination and high thermal uniformity.

**O-ring seal valves (e.g. XLF-2, XLFV-2, XLJ, XLG-2):** Suitable for high-speed/high-operating cycle high-vacuum applications, including systems where ease of maintenance and cost efficiency are priorities.



⊕ XLC Series



⊕ XLS Series



⊕ XLH Series

- Bellows/O-ring shaft seal
- Air/Electromagnetic operation
- Single/Double acting
- Portable equipment not requiring air.

# Slit valves

## High-vacuum parallel slit valves – precision sealing for demanding environments

### ⊕ XGTP Series

SMC's XGTP Series parallel seal slit valves are designed to deliver high sealing performance and minimal particle generation in vacuum transfer systems. With a parallel closing mechanism, these valves ensure uniform contact pressure across the sealing surface, reducing wear and enhancing vacuum integrity – ideal for semiconductor and flat panel display manufacturing.

Engineered for clean operation and long service life, the XGTP series supports high-cycle applications and offers excellent resistance to contamination. Their compact design and smooth actuation make them a reliable choice for load-lock and transfer chambers where precision and cleanliness are critical.

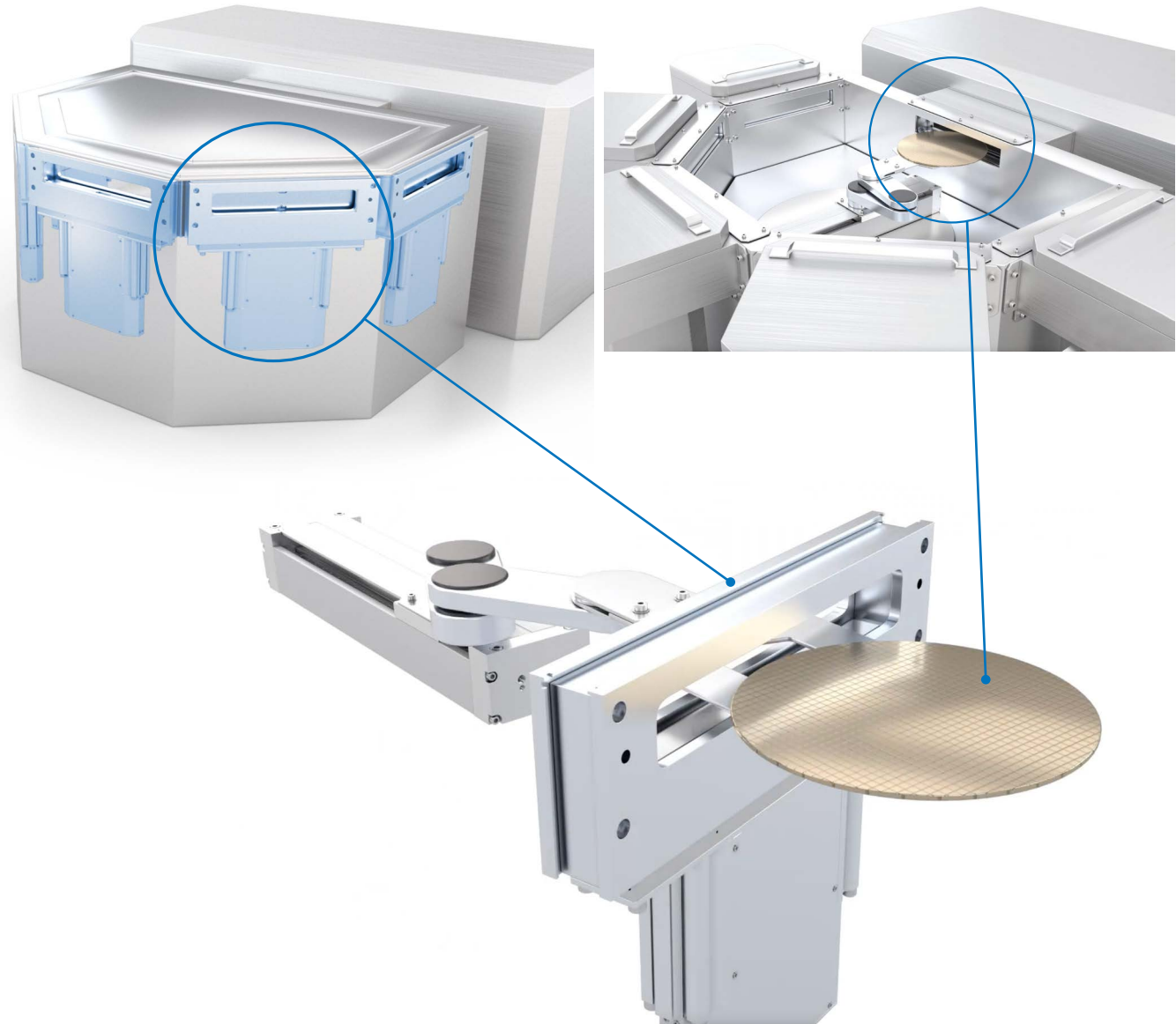
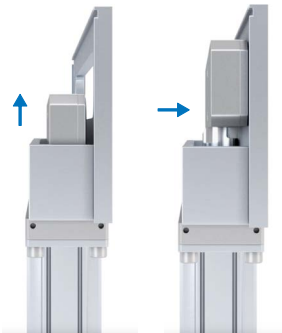

# Actuator for semiconductor industry

## Compact, clean and efficient vacuum actuation

### ⊕ CYV Series

SMC's CYV Series vacuum rodless cylinders are designed specifically for clean and space-constrained vacuum environments. With a rodless design that eliminates external sliding parts, the CYV series minimises particle generation and supports smooth, linear motion within vacuum chambers—ideal for semiconductor and electronics manufacturing.

Its compact profile, non-lubricated operation and compatibility with cleanroom standards make it a reliable solution for applications requiring precise, contamination-free actuation in high-vacuum conditions. Usable in wafer transfer processes.



# One-stop supplier



SMC offers a complete portfolio of components and solutions for high-vacuum applications, making us your one-stop supplier for this demanding field. From vacuum slit valves and valves to temperature control equipment and sensors, our products are engineered to deliver exceptional performance in environments where precision and reliability are critical.

Explore our full range of high-vacuum solutions and discover how SMC can support your application from start to finish.

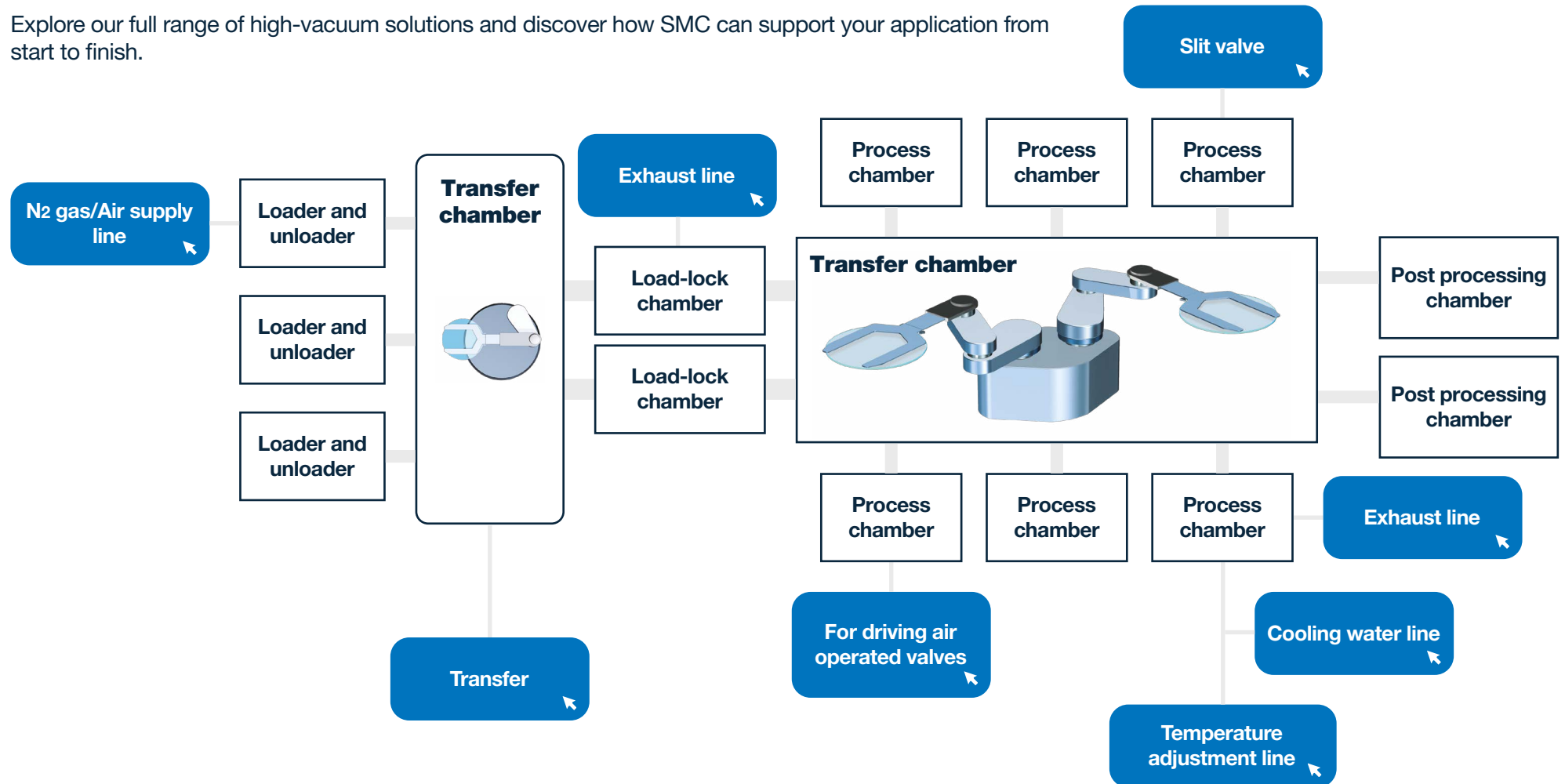

## N2 gas/Air supply line

To maintain chamber integrity and prevent contamination, clean nitrogen or air is introduced through controlled supply lines. These lines support valve actuation and chamber purging, ensuring stable pressure conditions during processing.



**SF□ Series +**  
Clean gas filter



**ISE20C(H) Series +**  
Digital pressure switch



**XM Series +**  
High-vacuum angle valve



**PFCQ Series +**  
Flow controller for air



**XVD +**  
Smooth vent valve



**XLG Series +**  
High-vacuum rubber seal angle valve



**AP/AZ/AK Series +**  
Regulator



**XSA Series +**  
High-vacuum solenoid valve



**XLD Series +**  
High-vacuum smooth exhaust valve

## Exhaust line

Efficient evacuation of process gases is critical for maintaining high vacuum levels. Exhaust lines equipped with smooth vent and angle valves enable controlled pressure release, minimising particle generation and ensuring rapid chamber recovery.

# Slit valve & Transfer

Slit valves enable clean and precise wafer transfer between vacuum chambers, maintaining vacuum integrity during load-lock operations. Complementary components such as rodless cylinders and ionizers support smooth, particle-free motion and electrostatic discharge control, ensuring reliable and contamination-free handling throughout the transfer process.



**Serie XGTP +**

Slit valve



**XT661-X260 Series +**

Non-contact gripper



**CYV Series +**

Rodless cylinder for vacuum



**IZS/IZT Series +**

Ionizer

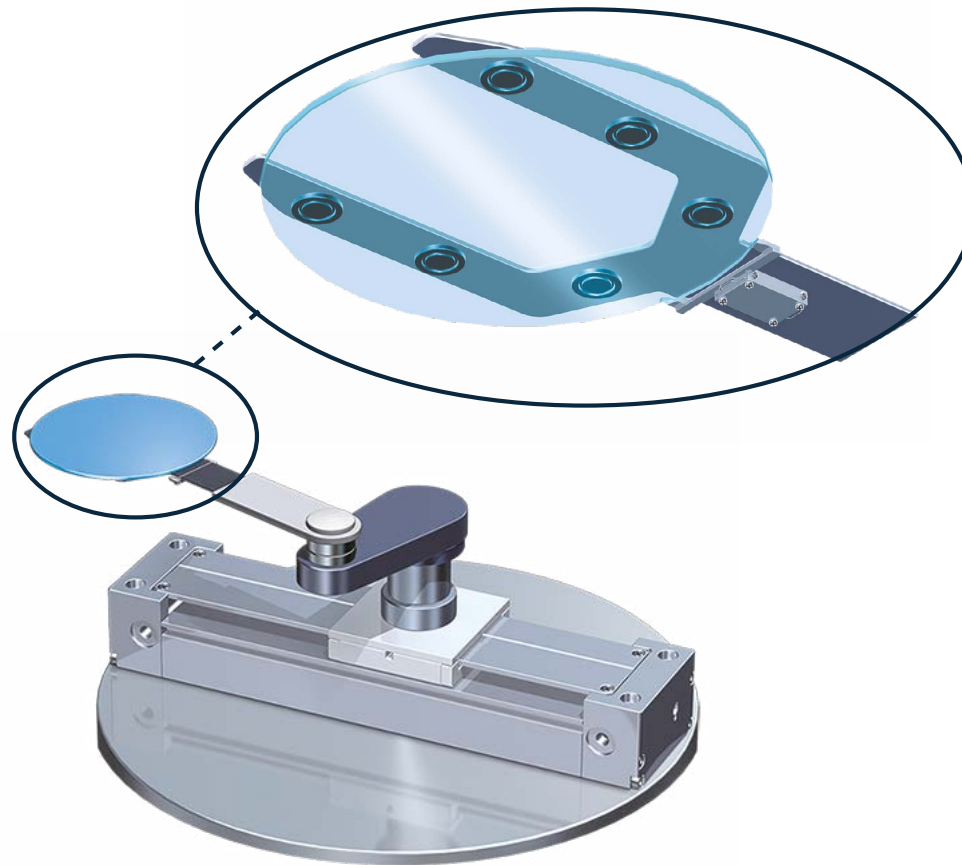

## For driving air-operated valve

Air-operated valves require a stable and clean pneumatic supply to function reliably in high-vacuum systems. Components such as 4-position dual 3-port valves and clean regulators ensure precise actuation, supporting consistent valve performance while minimising contamination risks.



**SJ Series +**

4-position dual 3-port valve



**SY Series +**

4-position dual 3-port valve

## Temperature adjustment line

Precise temperature control is essential in vacuum processes to ensure stable operating conditions and protect sensitive components. Thermo-chillers and digital flow switches regulate thermal parameters efficiently, supporting consistent performance and process reliability.



**KKA Series +**

S coupler



**HRZC +**

Non F-Gas (CO<sub>2</sub> refrigerant)  
Thermo-chiller

## Cooling water line

Cooling water systems help dissipate heat generated during vacuum operations, safeguarding equipment and maintaining optimal chamber conditions. Filters and flow control valves ensure clean and stable water circulation, reducing the risk of contamination and thermal fluctuations.



**FQ1 Series +**

Filter for water



**PF3W-Z Series +**

Digital flow switch



**ISE20C(H) Series +**

Digital pressure switch



**SF Series +**

Clean regulator



**JSX +**

Direct-operated 2/3-port  
solenoid valve

# Manufacturing quality

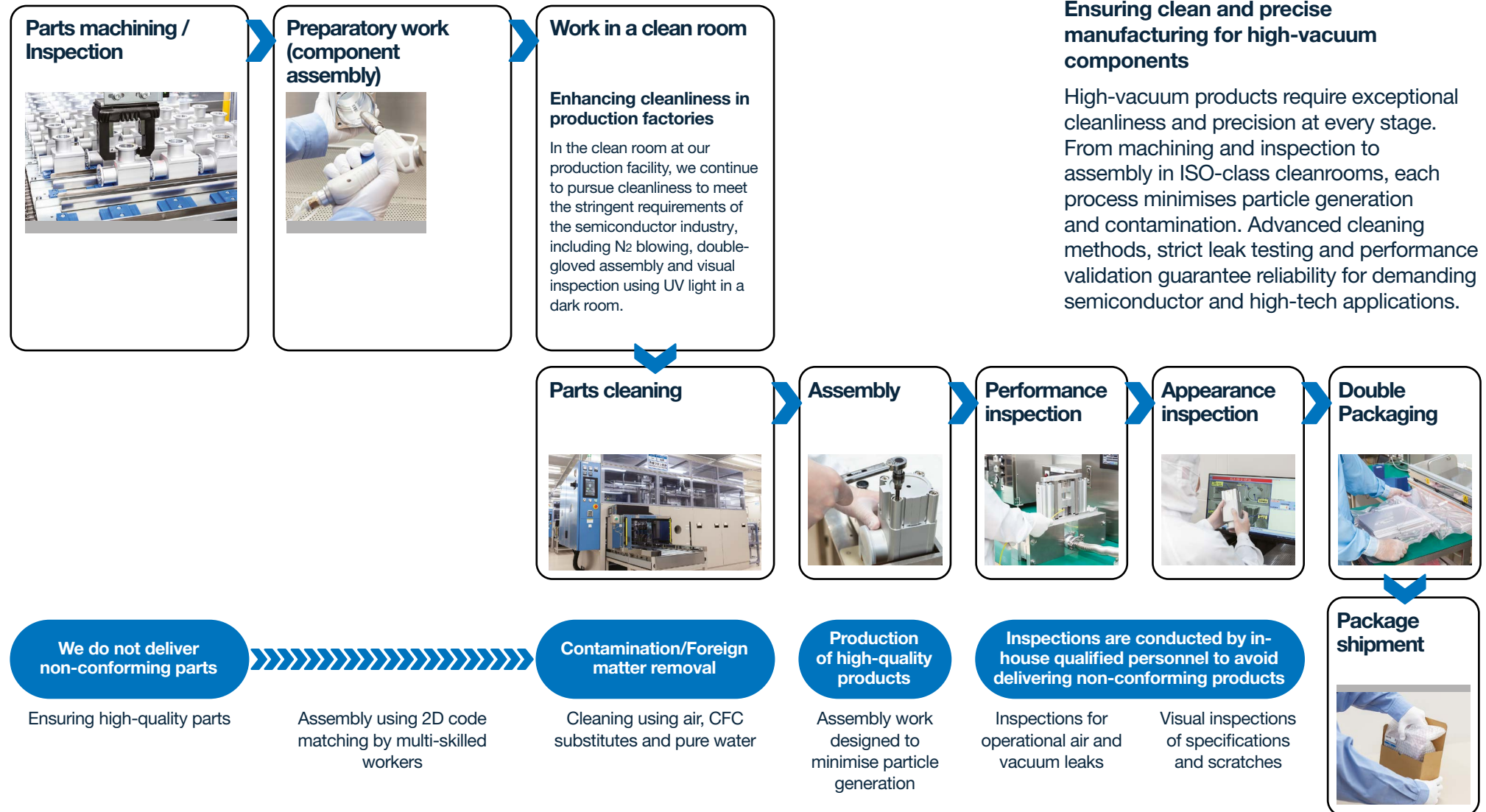

# Design tech-support

**1 Identification of specifications that meet customer requirements**

**2 Development of components that meet customer requirements**

Development of highly reliable components

Developing components cooperatively with parts manufacturers

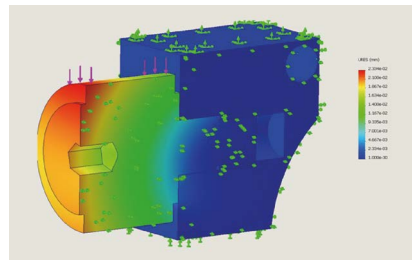
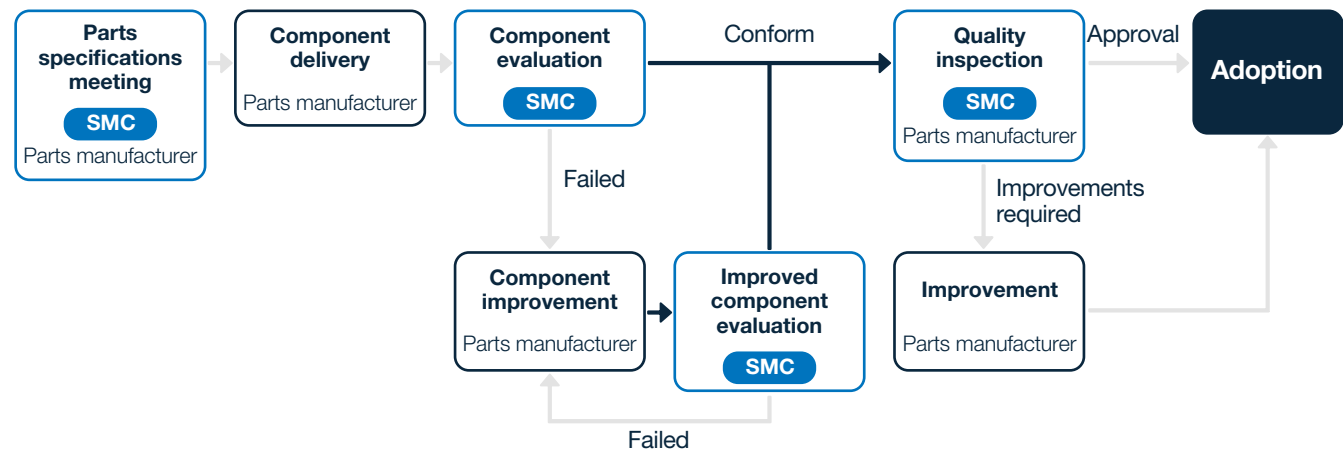

Evaluation of slit valve drive unit (stress analysis)

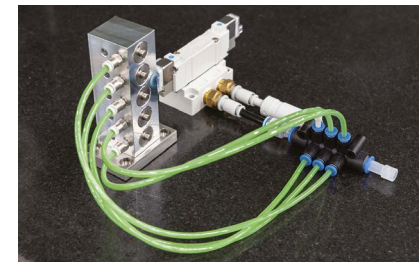

End lock evaluation of slit valves (endurance test)

# 3 Development of high-vacuum products that meet customer needs

Low particle generation design techniques based on stress and operation analysis of products

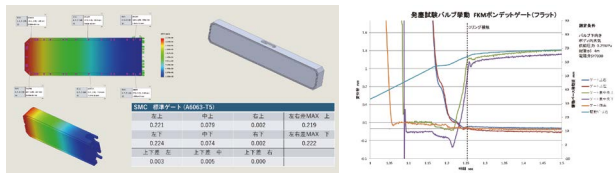

Gate design utilizing simulation



Optimal flow path design of valves through molecular flow conductance analysis

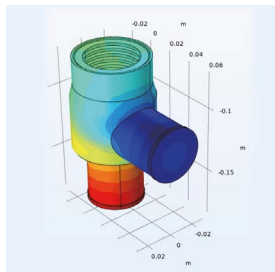

# 4 Reliability assessments



Helium leak testing



Particle measurement



Endurance testing



Noise testing

## Technical support

The optimum size of high-vacuum products varies depending on the customer's application. SMC carefully listens to customer feedback prior to introduction, prepares evaluation samples if necessary and provides support to ensure optimal product supply.

## Performance testing

Product performance is tested through a variety of validation procedures.

We pursue high quality and achieve high vacuum with minimal leakage.

## Selection support

We provide technical advice for the selection of the best equipment to meet customers' operating conditions.

# Our support network

## SMC's worldwide commitment

One of the things we do best at SMC is **being close to our customers**. Local support, on a global scale.

With support in over **500 locations** across **80 countries** and regions **worldwide**, our sales force of **7000 experts** maintains **close communication with customers**.

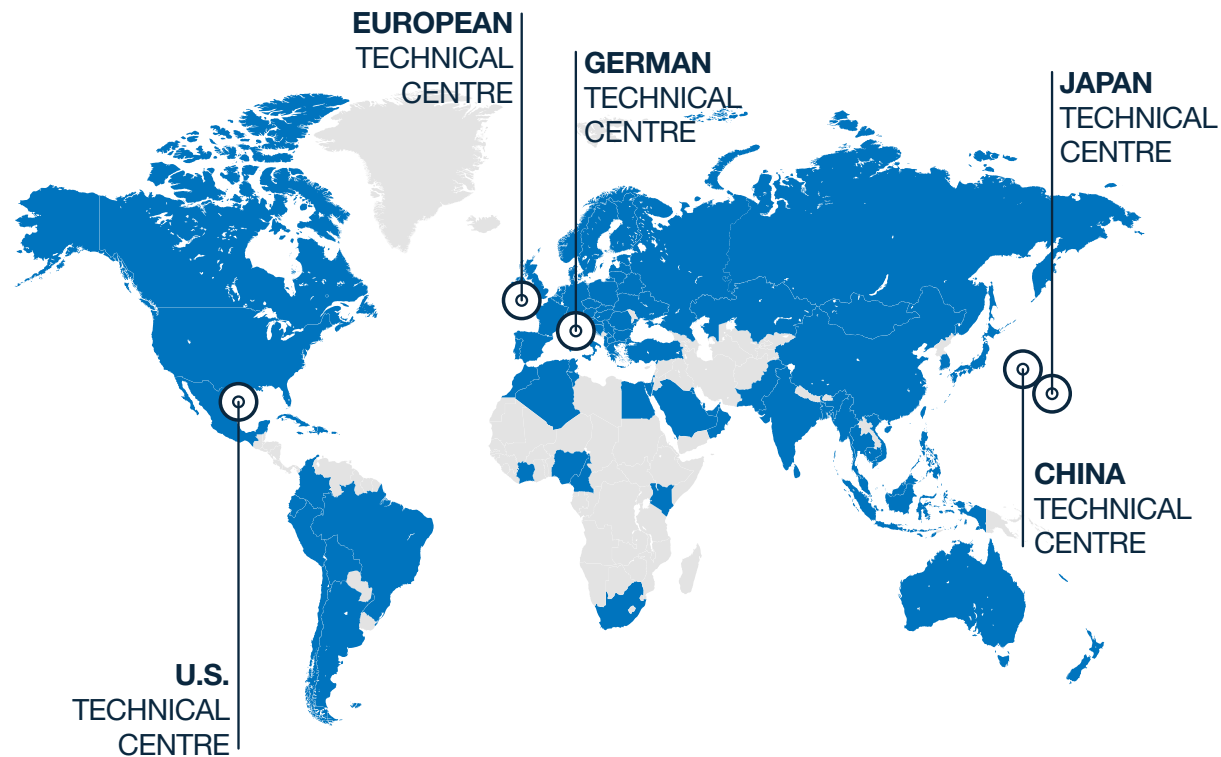

# SMC Business Continuity Plan

## Sustainable growth also means ensuring uninterrupted operations

We are committed to ensuring that SMC is prepared for any emergency and that our business activities will not stop in the event of such circumstances. SMC aims to fulfil our product supply responsibilities and maintain our customers' trust by contributing to both sustainable growth and the expansion of technological innovations.

SMC, as a comprehensive manufacturer of automatic control equipment that supports automation, is able to promptly provide products that meet our customers' needs anywhere in the world.

## Production BCP

### Ensure customer order fulfilment

Reliable delivery for you thanks to our 9 global logistic centres and 38 production sites worldwide, 10 of which are located in Europe. Moreover, flexibility to rapidly respond to any sudden change in the manufacturing environment.

## Finance BCP

### Safe & Solid financial base

In the event of an emergency, SMC can provide a safe and solid financial base (with cash, deposits, and equity capital) that will sufficiently cover the working capital and funds needed to rebuild buildings and the equipment required for business continuity. This is done to provide peace of mind to our customers and workers alike.

## Information security BCP

### Vital data kept safe

Strengthen information security for protection against computer viruses and cyberattacks, plus the installation of data centres to establish a disaster recovery system. Your information is safe with us.

## Engineering BCP

### Consistent technical support

2,100 engineers at our 5 technical centres around the globe (2 in Europe – Germany and UK).

## Sales BCP

### Consistent sales support

7,000 sales engineers worldwide ready to recommend the best solution for you. Over 80 global locations to make sure that wherever you are, we are there too.

[+ Discover more](#)



## SMC Corporation

1-5-5, Kyobashi,  
Chuo-ku, Tokyo  
104-0031, Japan  
Telephone: 03-6628-3000  
<https://www.smcworld.com>

<b>Austria</b>	+43 (0)2262622800	<a href="http://www.smc.at">www.smc.at</a>	<a href="mailto:office.at@smc.com">office.at@smc.com</a>						
<b>Belgium</b>	+32 (0)33551464	<a href="http://www.smc.be">www.smc.be</a>	<a href="mailto:info@smc.be">info@smc.be</a>						
<b>Bulgaria</b>	+359 (0)2807670	<a href="http://www.smc.bg">www.smc.bg</a>	<a href="mailto:sales.bg@smc.com">sales.bg@smc.com</a>						
<b>Croatia</b>	+385 (0)13707288	<a href="http://www.smc.hr">www.smc.hr</a>	<a href="mailto:sales.hr@smc.com">sales.hr@smc.com</a>						
<b>Czech Republic</b>	+420 541424611	<a href="http://www.smc.cz">www.smc.cz</a>	<a href="mailto:office.at@smc.com">office.at@smc.com</a>						
<b>Denmark</b>	+45 70252900	<a href="http://www.smc.dk.com">www.smc.dk.com</a>	<a href="mailto:smc.dk@smc.com">smc.dk@smc.com</a>						
<b>Estonia</b>	+372 651 0370	<a href="http://www.smcee.ee">www.smcee.ee</a>	<a href="mailto:info.ee@smc.com">info.ee@smc.com</a>						
<b>Finland</b>	+358 207513513	<a href="http://www.smc.fi">www.smc.fi</a>	<a href="mailto:smc.fi@smc.com">smc.fi@smc.com</a>						
<b>France</b>	+33 (0)164761000	<a href="http://www.smc-france.fr">www.smc-france.fr</a>	<a href="mailto:supportclient.fr@smc.com">supportclient.fr@smc.com</a>						
<b>Germany</b>	+49 (0)61034020	<a href="http://www.smc.de">www.smc.de</a>	<a href="mailto:info.de@smc.com">info.de@smc.com</a>						
<b>Greece</b>	+30 210 2717265	<a href="http://www.smchellas.gr">www.smchellas.gr</a>	<a href="mailto:sales@smchellas.gr">sales@smchellas.gr</a>						
<b>Hungary</b>	+36 23513000	<a href="http://www.smc.hu">www.smc.hu</a>	<a href="mailto:office.hu@smc.com">office.hu@smc.com</a>						
<b>Ireland</b>	+353 (0)14039000	<a href="http://www.smcautomation.ie">www.smcautomation.ie</a>	<a href="mailto:technical.ie@smc.com">technical.ie@smc.com</a>						
<b>Italy</b>	+39 03990691	<a href="http://www.smcitalia.it">www.smcitalia.it</a>	<a href="mailto:mailbox.it@smc.com">mailbox.it@smc.com</a>						
<b>Latvia</b>	+371 67817700	<a href="http://www.smc.lv">www.smc.lv</a>	<a href="mailto:info.lv@smc.com">info.lv@smc.com</a>						
<b>Lithuania</b>	+370 5 2308118	<a href="http://www.smclt.lt">www.smclt.lt</a>	<a href="mailto:info.lt@smc.com">info.lt@smc.com</a>						
<b>Netherlands</b>	+31 (0)205318888	<a href="http://www.smc.nl">www.smc.nl</a>	<a href="mailto:info@smc.nl">info@smc.nl</a>						
<b>Norway</b>	+47 67129020	<a href="http://www.smc-norge.no">www.smc-norge.no</a>	<a href="mailto:post.no@smc.com">post.no@smc.com</a>						
<b>Poland</b>	+48 22 344 40 00	<a href="http://www.smc.pl">www.smc.pl</a>	<a href="mailto:office.pl@smc.com">office.pl@smc.com</a>						
<b>Portugal</b>	+351 214724500	<a href="http://www.smc.eu">www.smc.eu</a>	<a href="mailto:apoiocliente.pt@smc.com">apoiocliente.pt@smc.com</a>						
<b>Romania</b>	+40 213205111	<a href="http://www.smcromania.ro">www.smcromania.ro</a>	<a href="mailto:office.ro@smc.com">office.ro@smc.com</a>						
<b>Russia</b>	+7 (812)3036600	<a href="http://www.smc.eu">www.smc.eu</a>	<a href="mailto:sales@smcru.com">sales@smcru.com</a>						
<b>Slovakia</b>	+421 (0)413213212	<a href="http://www.smc.sk">www.smc.sk</a>	<a href="mailto:sales.sk@smc.com">sales.sk@smc.com</a>						
<b>Slovenia</b>	+386 (0)73885412	<a href="http://www.smc.si">www.smc.si</a>	<a href="mailto:office.si@smc.com">office.si@smc.com</a>						
<b>Spain</b>	+34 945184100	<a href="http://www.smc.eu">www.smc.eu</a>	<a href="mailto:post.es@smc.com">post.es@smc.com</a>						
<b>Sweden</b>	+46 (0)86031240	<a href="http://www.smc.nu">www.smc.nu</a>	<a href="mailto:order.se@smc.com">order.se@smc.com</a>						
<b>Switzerland</b>	+41 (0)523963131	<a href="http://www.smc.ch">www.smc.ch</a>	<a href="mailto:helpcenter.ch@smc.com">helpcenter.ch@smc.com</a>						
<b>Turkey</b>	+90 212 489 0 440	<a href="http://www.smcturkey.com.tr">www.smcturkey.com.tr</a>	<a href="mailto:satis.tr@smc.com">satis.tr@smc.com</a>						
<b>UK</b>	+44 (0)845 121 5122	<a href="http://www.smc.uk">www.smc.uk</a>	<a href="mailto:sales.gb@smc.com">sales.gb@smc.com</a>						
<b>South Africa</b>	+27 10 900 1233	<a href="http://www.smcza.co.za">www.smcza.co.za</a>	<a href="mailto:Sales.za@smc.com">Sales.za@smc.com</a>						

## www.smc.eu

Release EP  
HIGH-VACUUM-A-EN

SPECIFICATIONS ARE SUBJECT TO CHANGE WITHOUT PRIOR NOTICE AND ANY OBLIGATION ON THE PART OF THE MANUFACTURER